

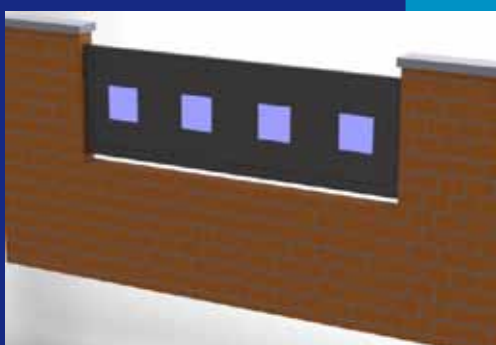

**INDUSTRIAS CANYELLES BCN S.L.**



***VALLAS***



***CANCELAS***



***PUERTAS JARDIN***



***PUERTAS JARDIN DOBLES***

FABRICANTES DE

**EXTRUAL** SISTEMAS

## INDUSTRIAS CANYELLES BCN S.L.

Es una empresa dedicada a la fabricación de carpintería de aluminio, hemos ido creciendo según las necesidades del mercado, formando profesionales con una larga trayectoria en el sector de la fabricación de puertas y ventanas de aluminio.

Somos especialistas en la fabricación de elementos de aluminio especiales como cerramientos de seguridad para locales, comercios...

Hemos dotado nuestras instalaciones de los métodos más avanzados en tecnología para la fabricación de puertas y ventanas de aluminio con las máximas garantías de aislamiento y estanqueidad, trabajando siempre con perfiles de primera calidad.

Nuestros productos aportan diseño, calidad e innovación con una amplia oferta que satisfacen las necesidades de nuestros clientes.

**Somos fabricantes de carpintería de aluminio  
especializados en cerramientos y elementos  
de seguridad.**



INDICE

VALLAS..... pág.5



PUERTAS JARDIN..... pág.13



PUERTA JARDIN DOBLE..... pág.19



PERFILES VALLAS Y PUERTAS..... pág.24

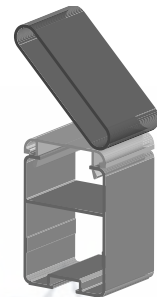

CANCELAS CORREDERAS..... pág.33

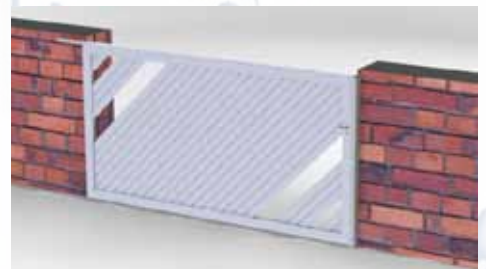

PERFILES CANCELAS CORREDERAS..... pág.39

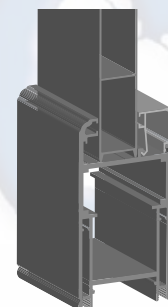



INDUSTRIAS CANYELLES BCN S.L.

# VALLAS



FABRICANTES DE

**EXTRUAL**

SISTEMAS

**LEDA**

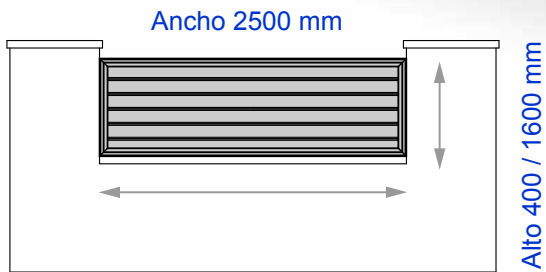
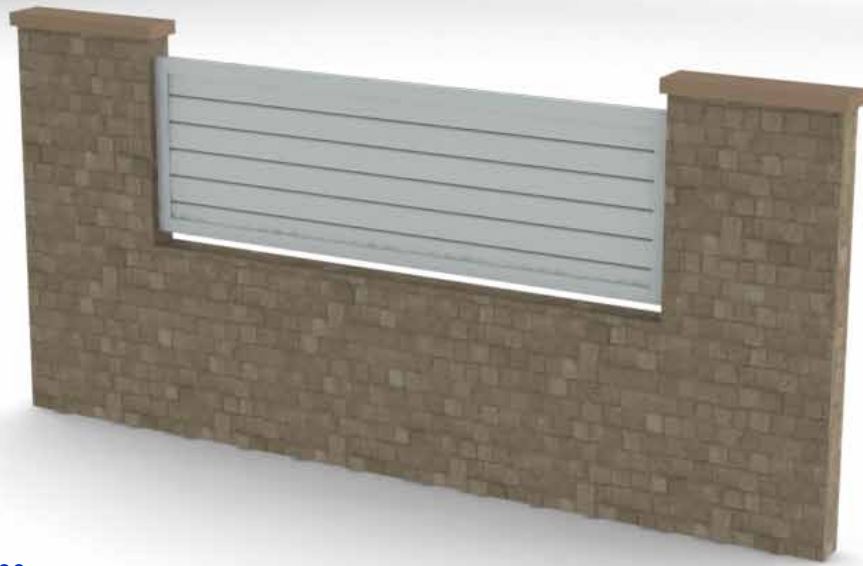

**LAMA MACHEMBRADA HORIZONTAL**

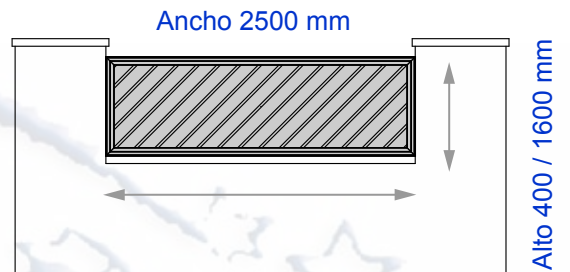

**LAMA MACHEMBRADA DIAGONAL**

**ZARA**

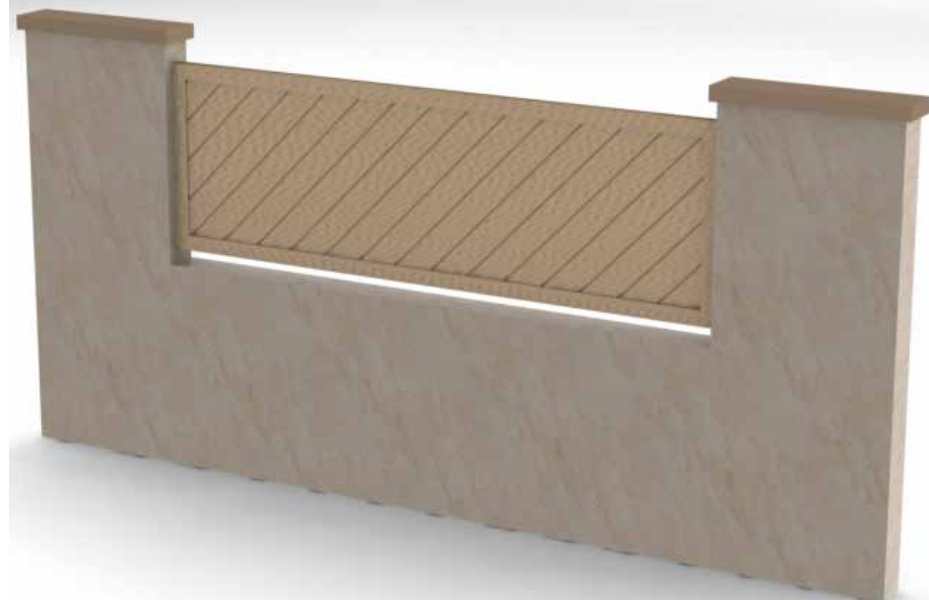

**INDRA**

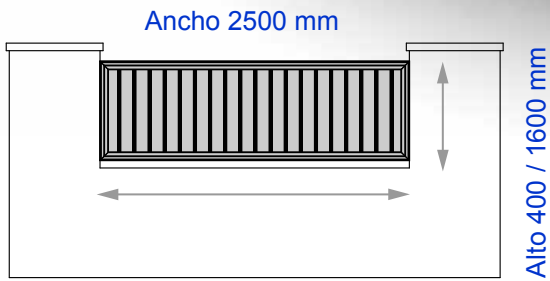

**LAMA MACHEMBRADA VERTICAL**

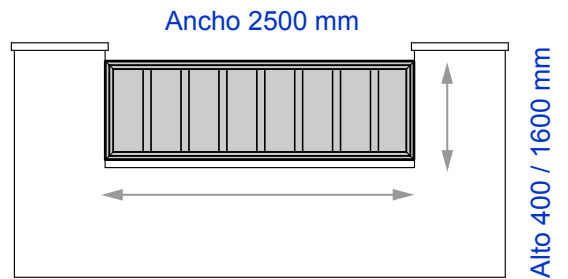

**DIVISION Y SANDWICH**

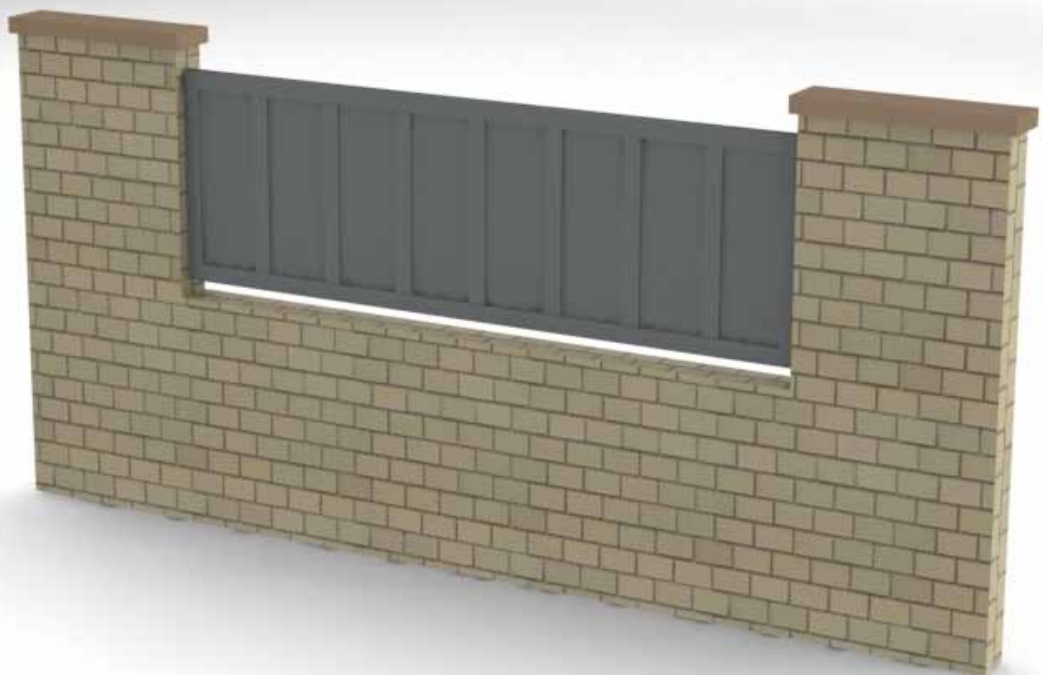

**IVANA**

**NORA**



Ancho 2500 mm

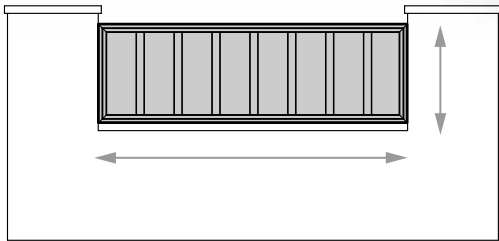

Alto 400 / 1600 mm

DIVISION

Ancho 2500 mm

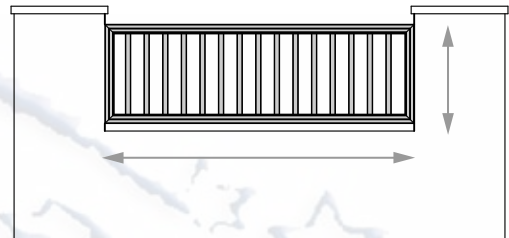

Alto 400 / 1600 mm

**BARROTES**

**ORIA**



**ONA**

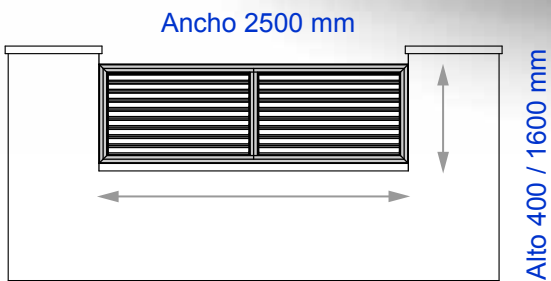

**LAMA ORIENTADA**

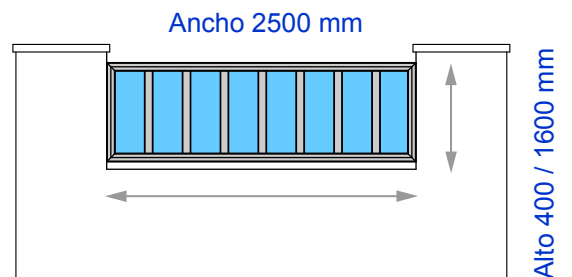

**DIVISION Y CRISTAL**

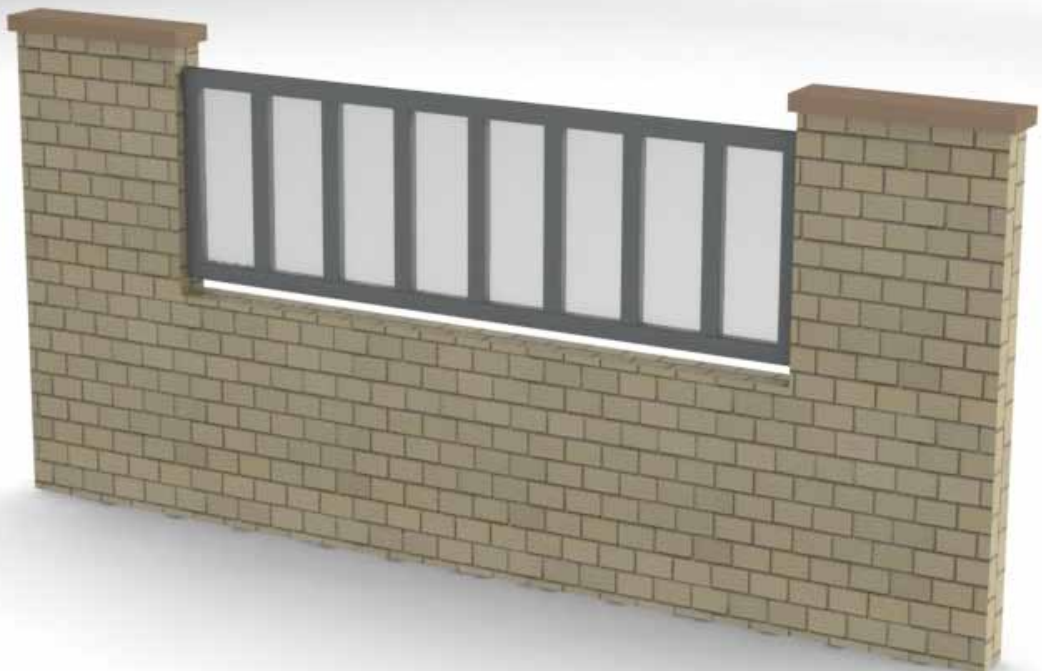

**KENDRA**



**DELMA**

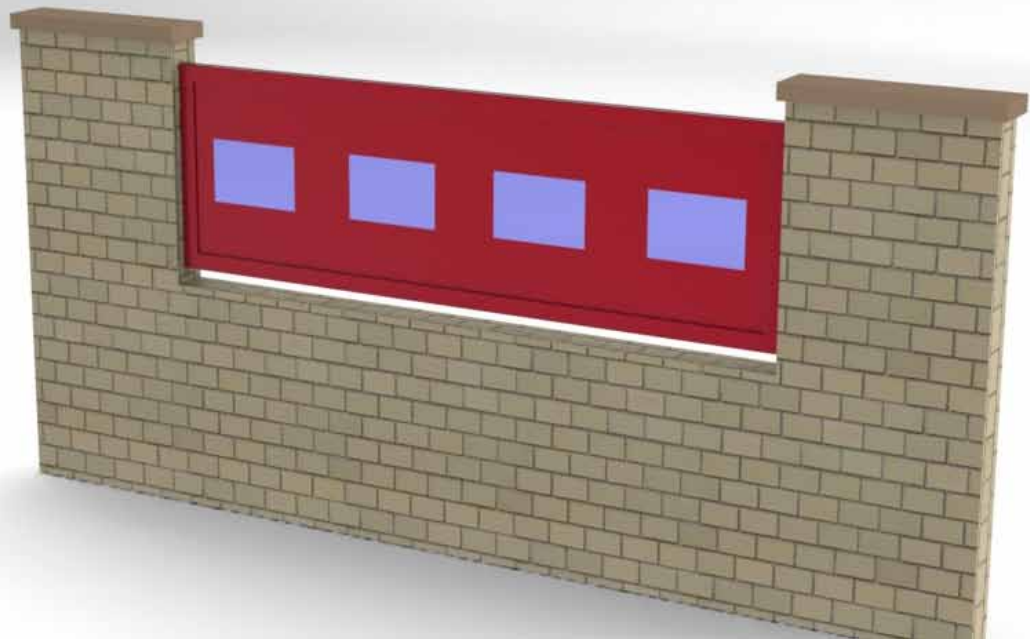

Ancho 2500 mm

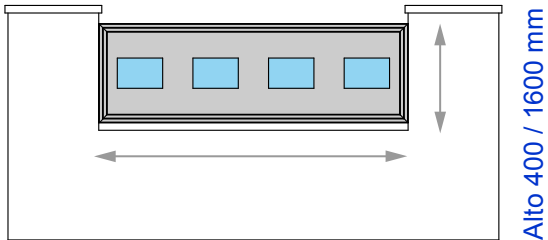

**VIDRIO RECTANGULAR**

Ancho 2500 mm

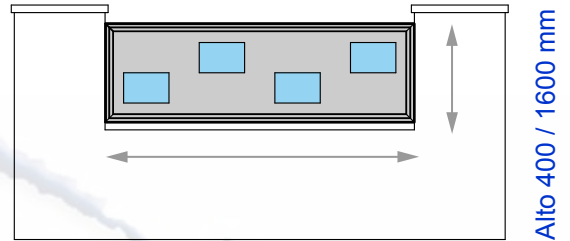

**VIDRIO RECTANGULAR ALTURAS DIFERENTES**

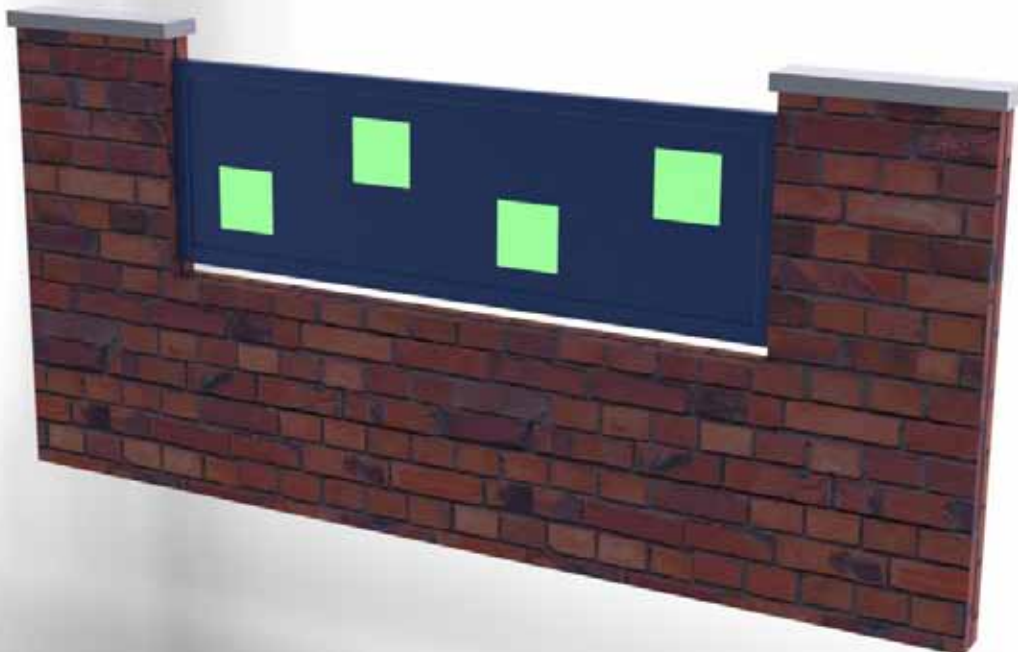

**DINA**

# VALLAS

VIDRIO CUADRADO

**OZANA**

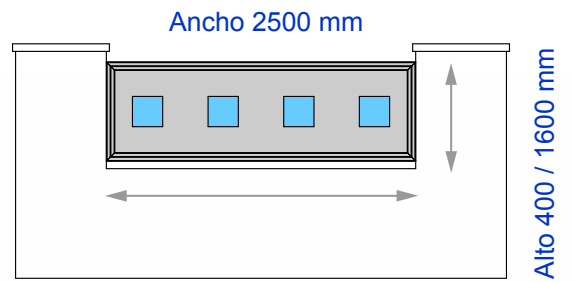
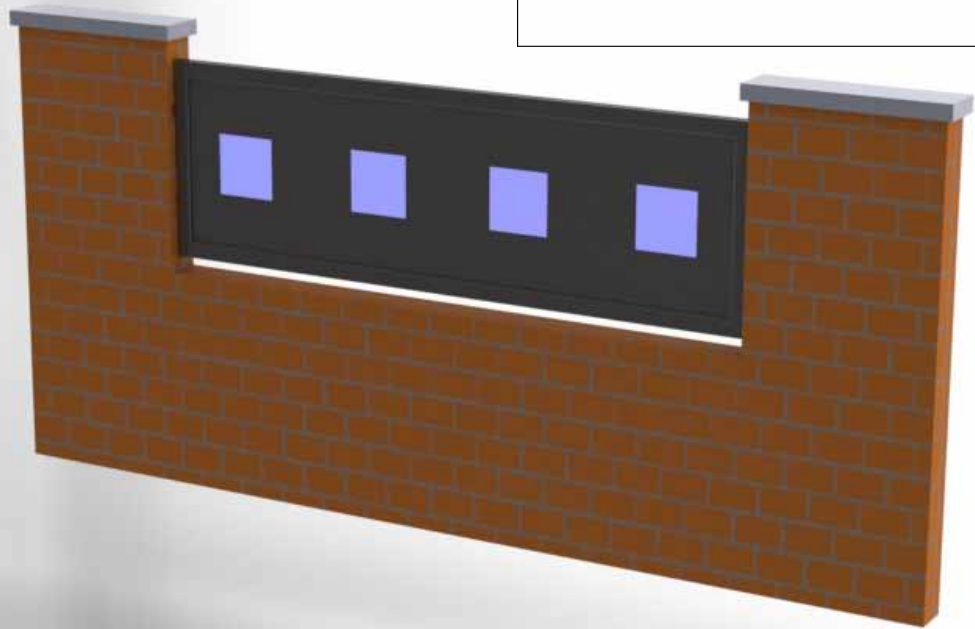

VIDRIO CUADRADO ALTURAS DIFERENTES

**TARA**

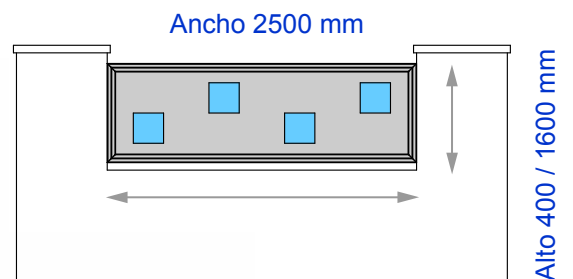
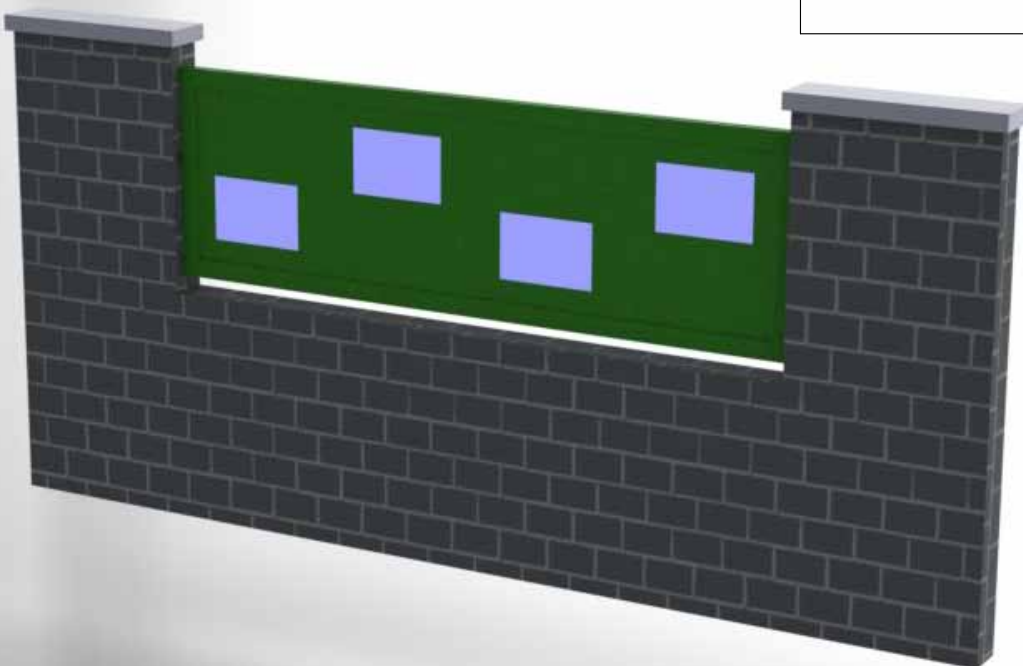

# VALLAS

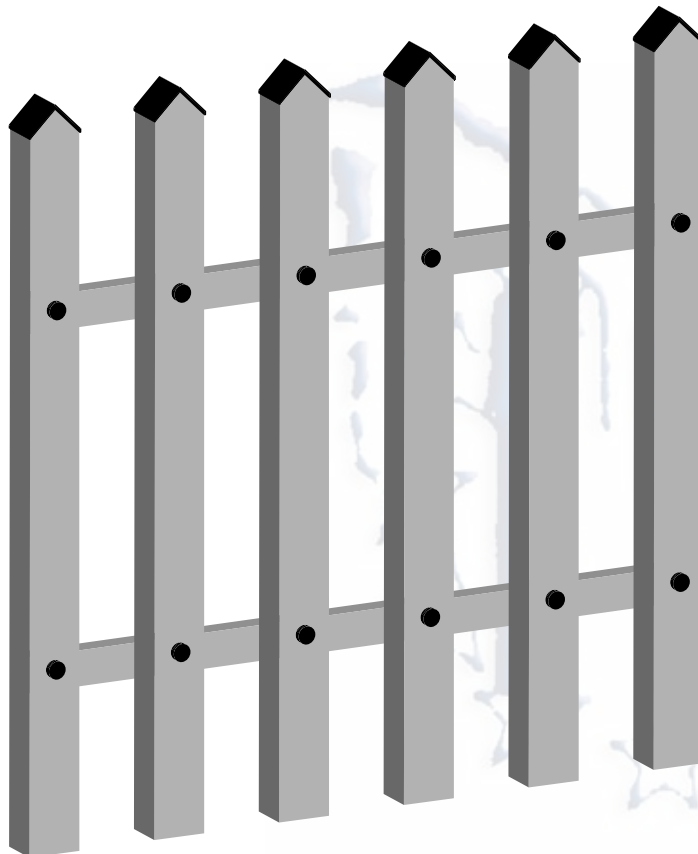
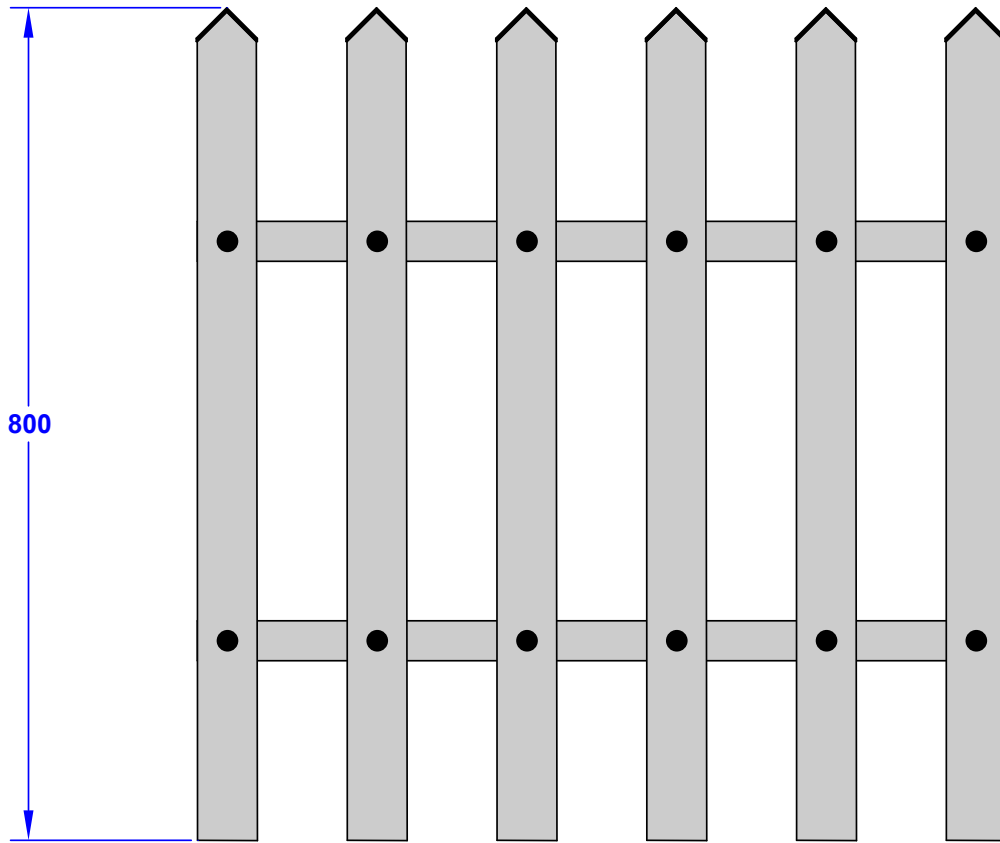



INDUSTRIAS CANYELLES BCN S.L.

## *PUERTAS JARDIN*



FABRICANTES DE

**EXTRUAL**

SISTEMAS



**COBA**

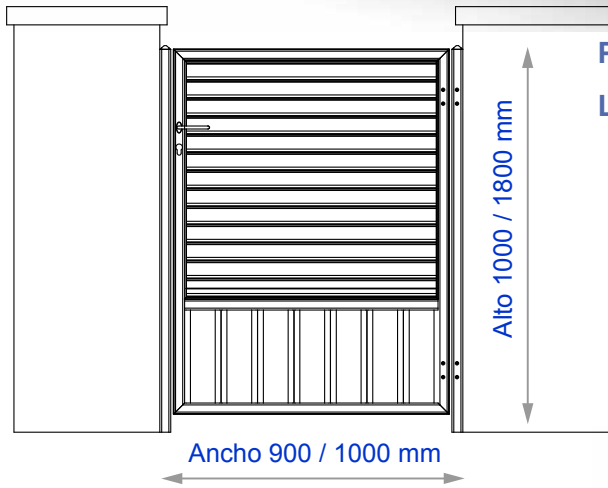

PARTE INFERIOR MACHEMBRADA  
LAMA ORIENTADA

LAMA ORIENTADA



**JORDANA**

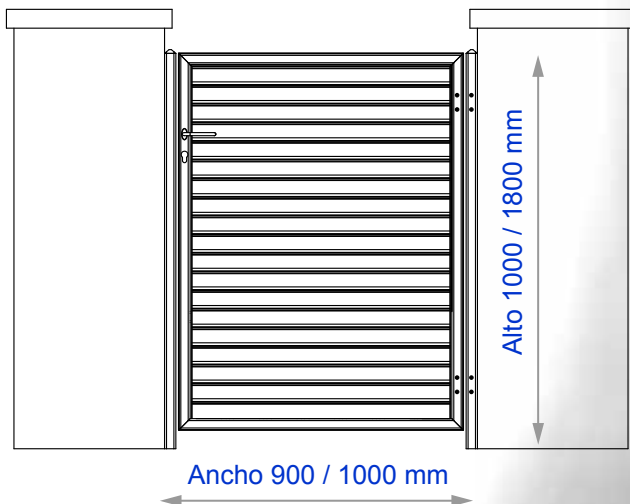



MACHEMBRADA VERTICAL

**ISONOE**

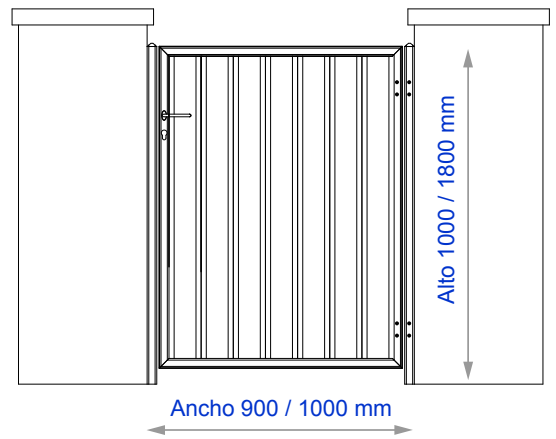

**TITANEA**

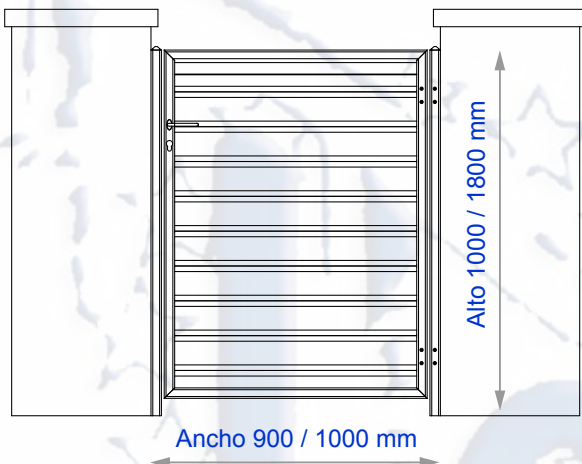

**LAMA MACHEMBRADA HORIZONTAL**





MACHEMBRADA DIAGONAL

**ISONOE DIAGO**

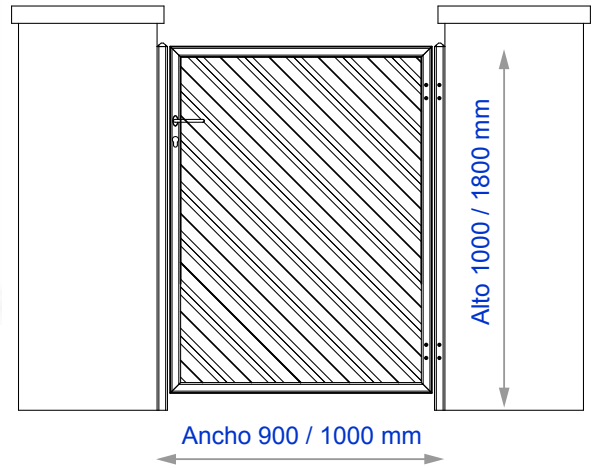

**DIVISION LAMA MACHEMBRADA**



**HALIMADES**



**TITANEA CRISTAL**

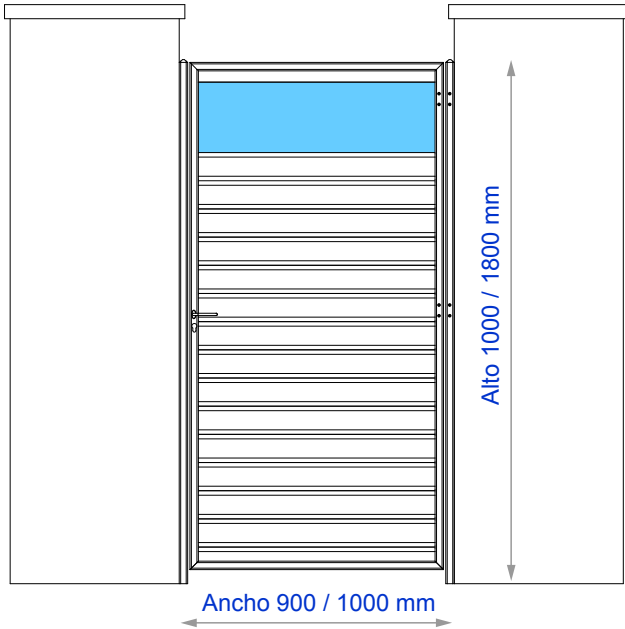

**LAMA MACHEMRADA HORIZONTAL CON VIDRIO**

**BARROTOS**

**THALASA**

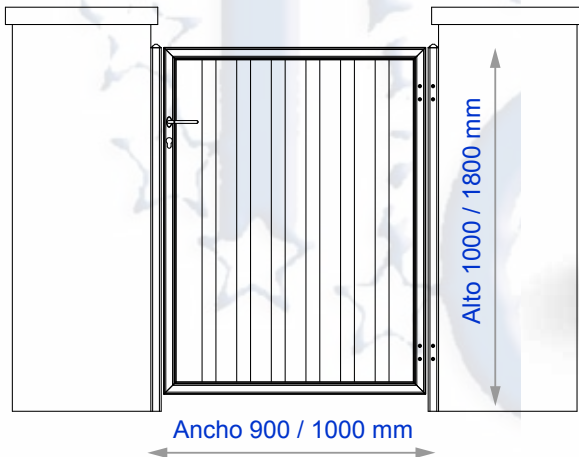





**BARROTES**  
**PARTE INFERIOR MACHEMBRADA**

**AMALTEA**

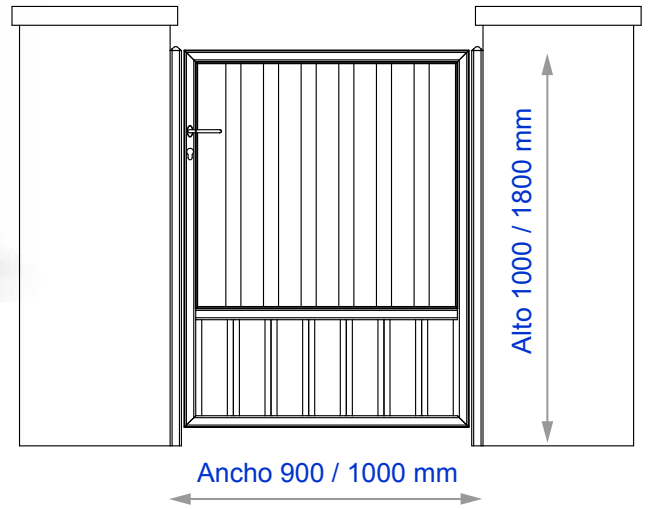



INDUSTRIAS CANYELLES BCN S.L.

## *PUERTAS JARDIN DOBLES*



FABRICANTES DE

**EXTRUAL**

SISTEMAS

# PUERTAS JARDIN DOBLE



**ALINA**

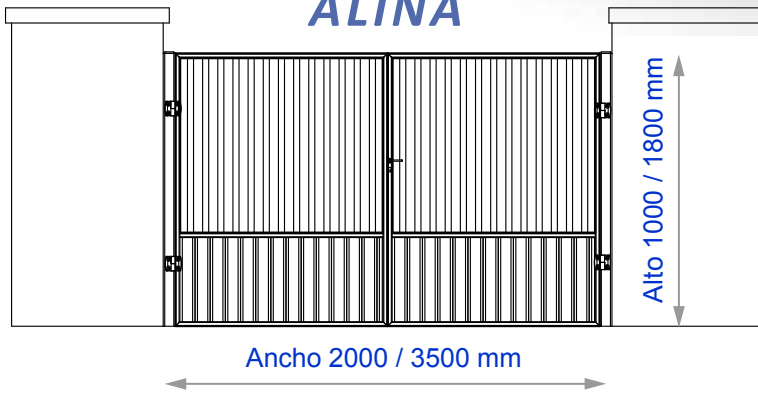

**BARROTES**

**PARTE INFERIOR MACHEMBRADA**

**ALBANA**

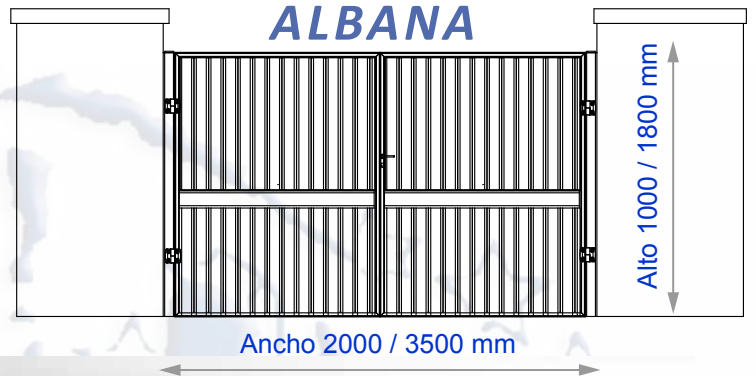

**MACHEMBRADA**



# PUERTAS JARDIN DOBLE



**ALTEA**

**BARROTES**

**PARTE INFERIOR MACHEMBRADA**

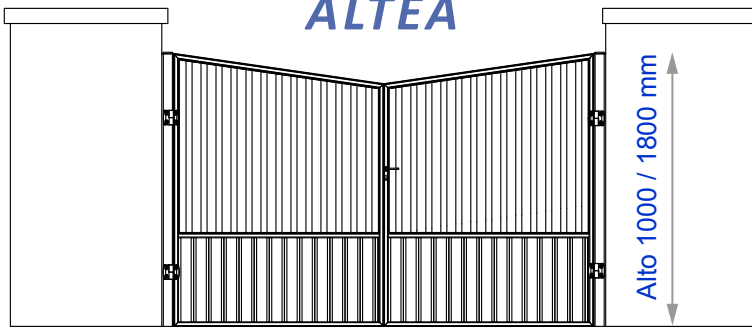

Ancho 2000 / 3500 mm

Alto 1000 / 1800 mm

**ALEGRA**



Ancho 2000 / 3500 mm

Alto 1000 / 1800 mm

**MACHEMBRADA**

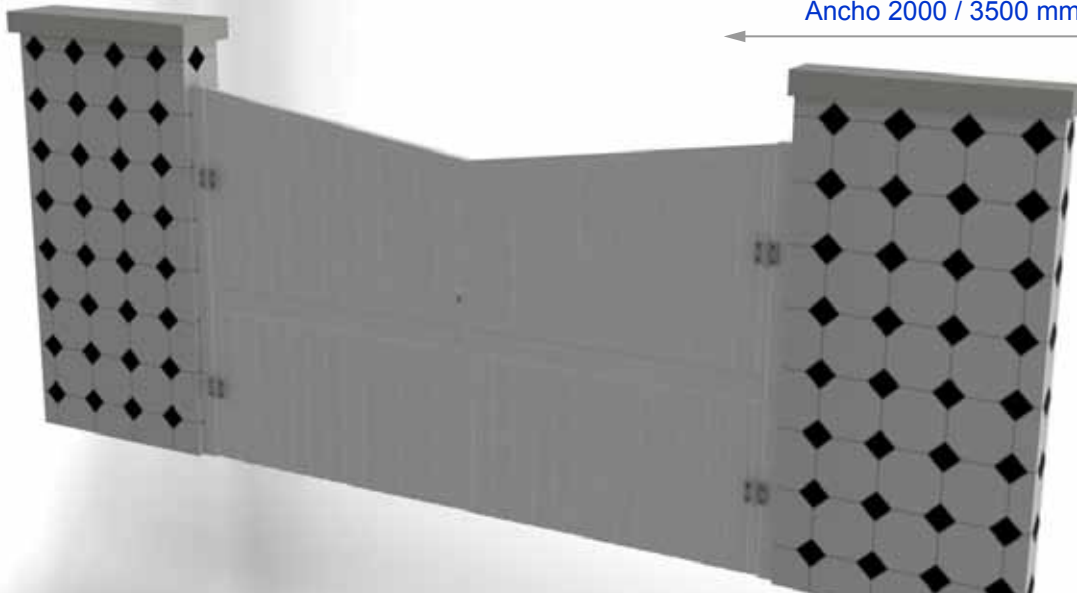

# PUERTAS JARDIN DOBLE

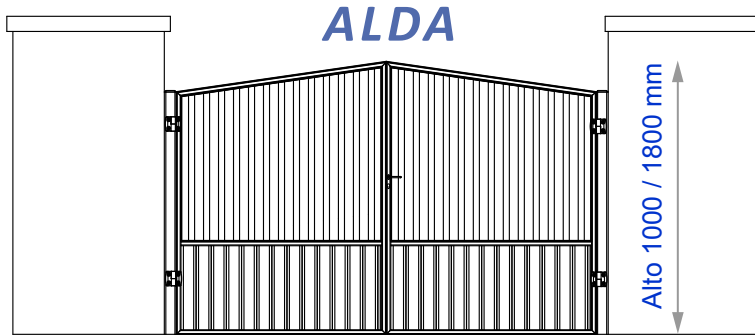

**ALDA**

**BARROTES**

**PARTE INFERIOR MACHEMBRADA**

Ancho 2000 / 3500 mm

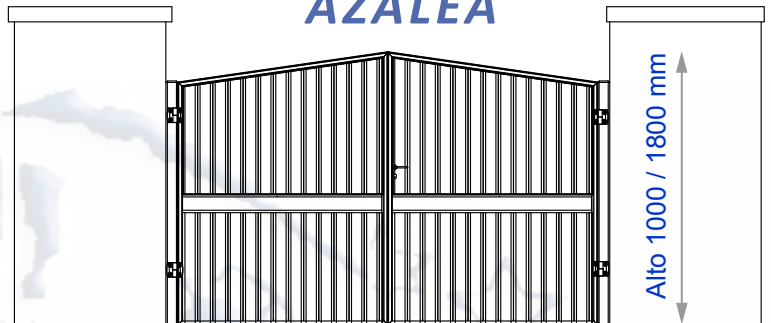

**AZALEA**

**MACHEMBRADA**

Ancho 2000 / 3500 mm



# PUERTAS JARDIN DOBLE



**EDA**

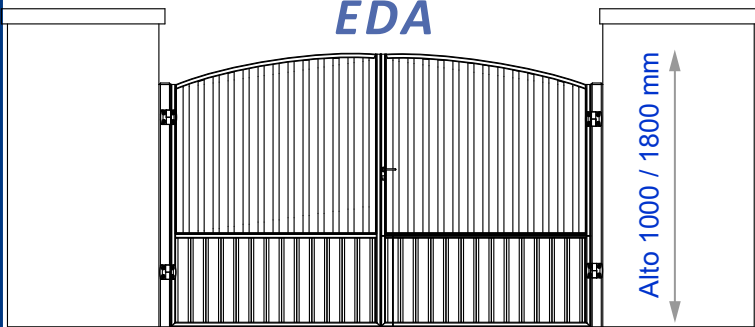

Ancho 2000 / 3500 mm

**BARROTES  
PARTE INFERIOR MACHEMBRADA**

**DELA**

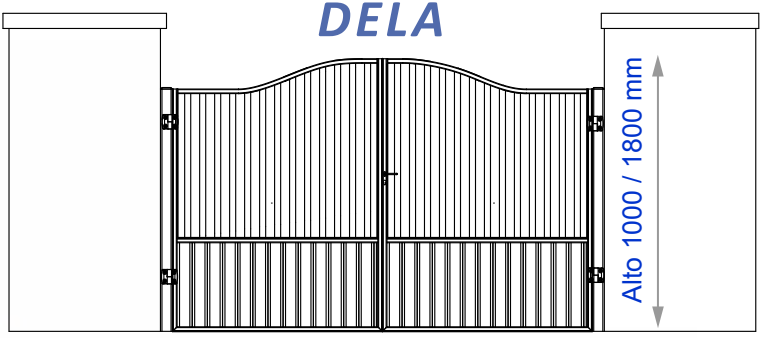

Ancho 2000 / 3500 mm

**BARROTES  
PARTE INFERIOR MACHEMBRADA**



# PUERTAS JARDIN DOBLE



**GALENA**

**MACHEMBRADA**

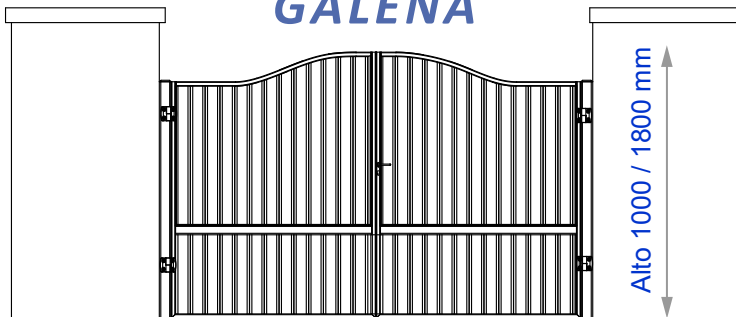

Ancho 2000 / 3500 mm

Alto 1000 / 1800 mm

**GALA**



**MACHEMBRADA**

Ancho 2000 / 3500 mm

Alto 1000 / 1800 mm

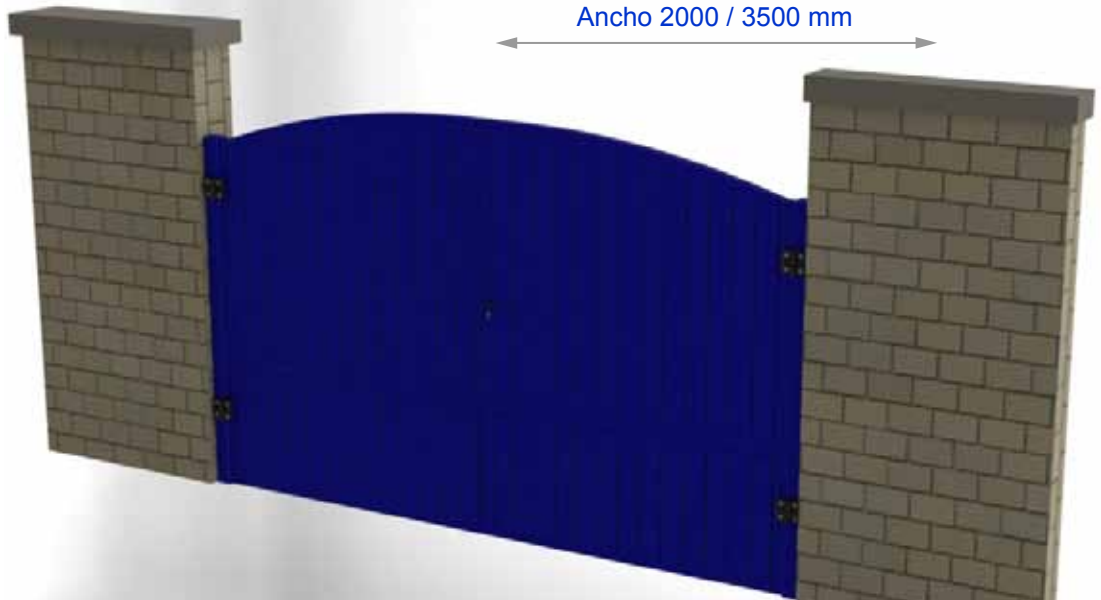

SECCION VERTICAL

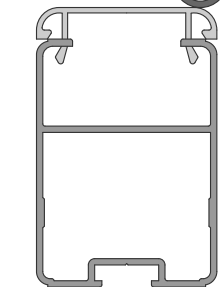
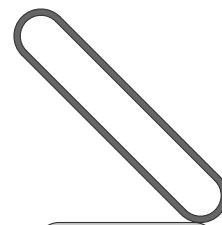
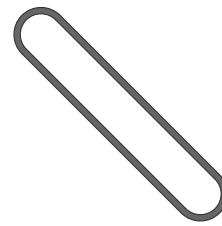
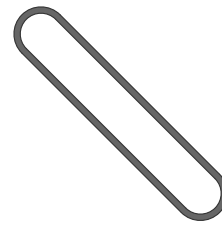
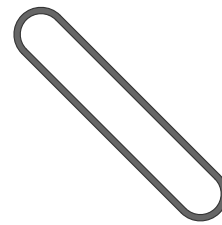
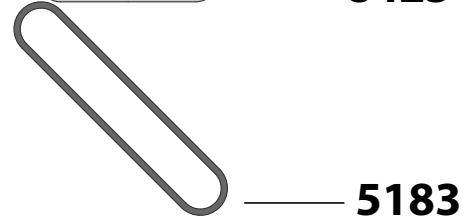
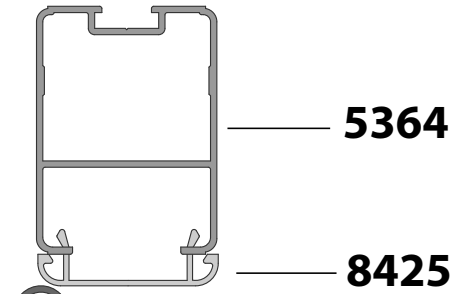
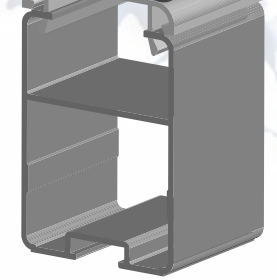
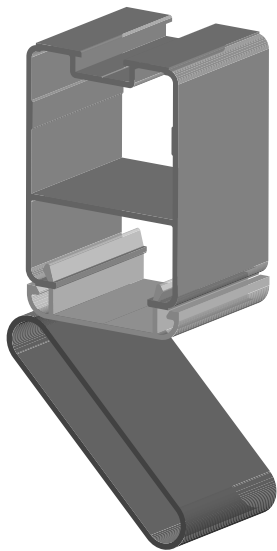



SECCION HORIZONTAL

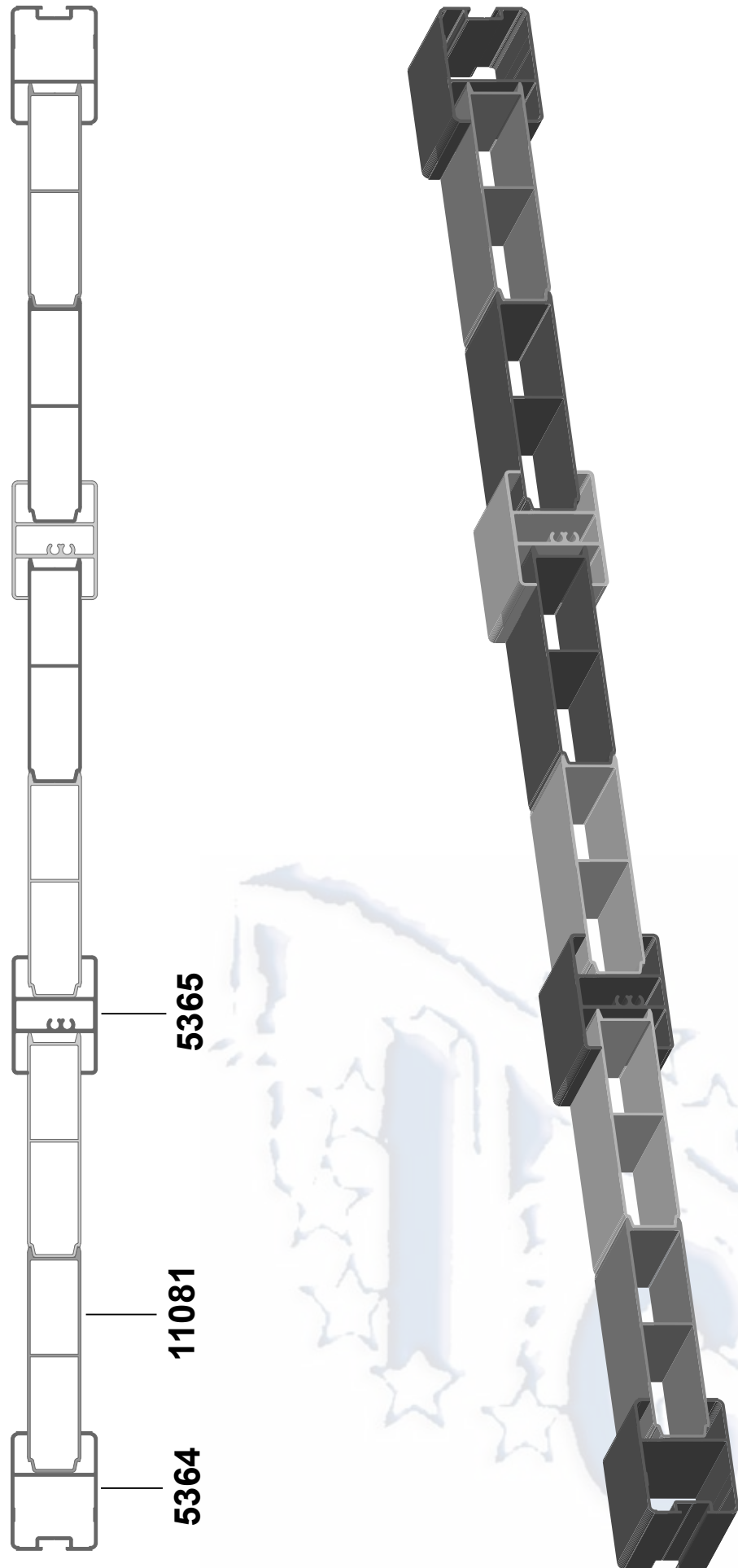

5176

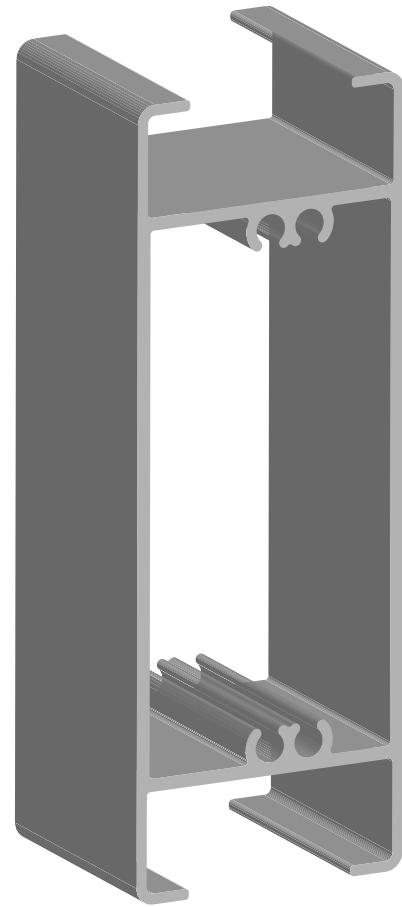
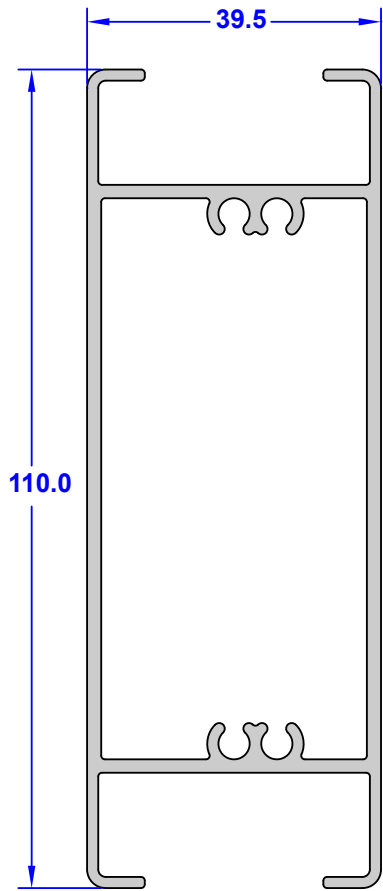

5183

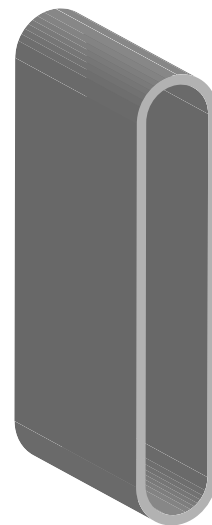
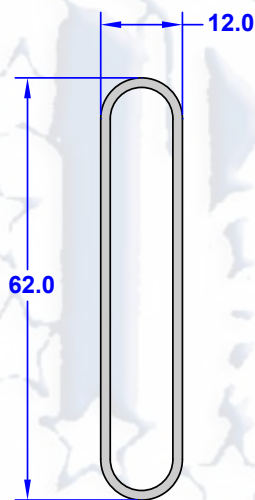

**5364**

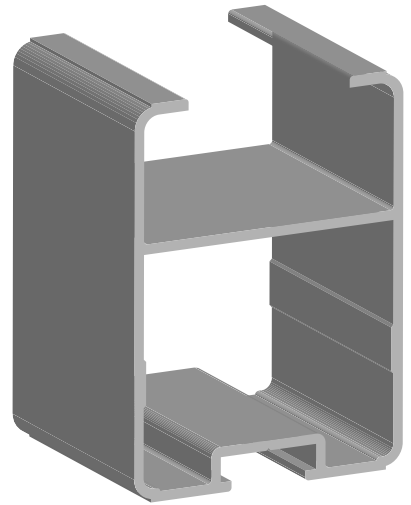
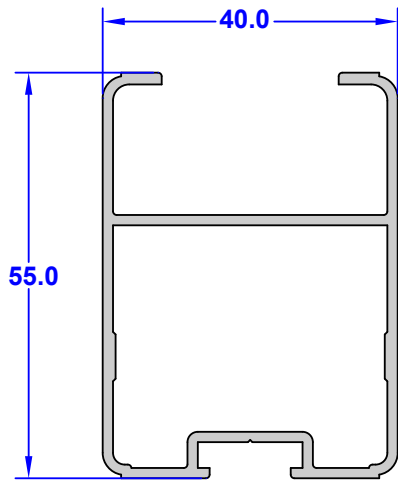

**5365**

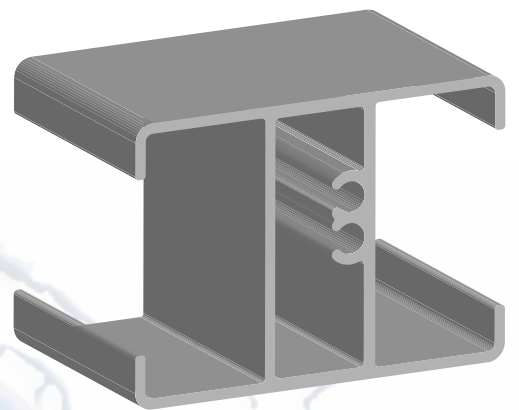
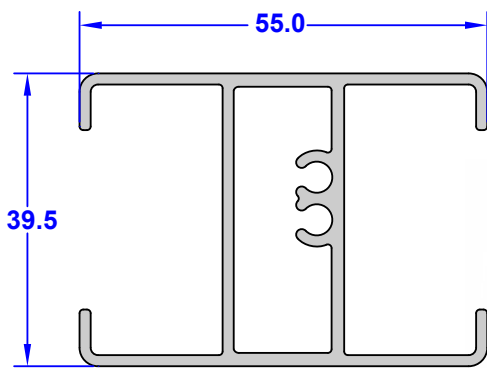

**7443**

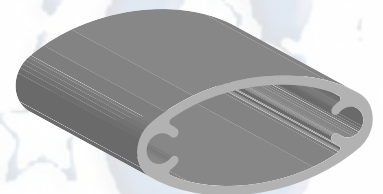
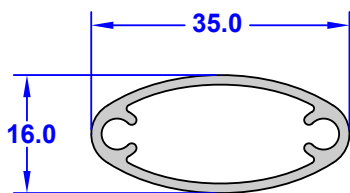

8425

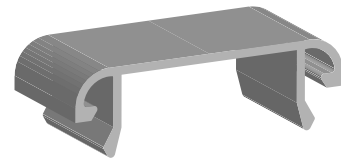
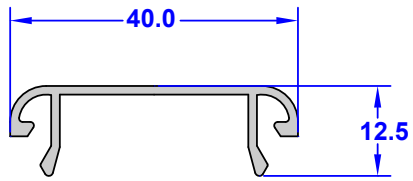

11081

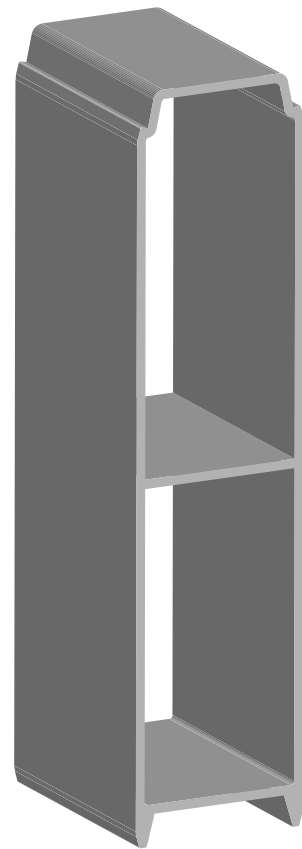
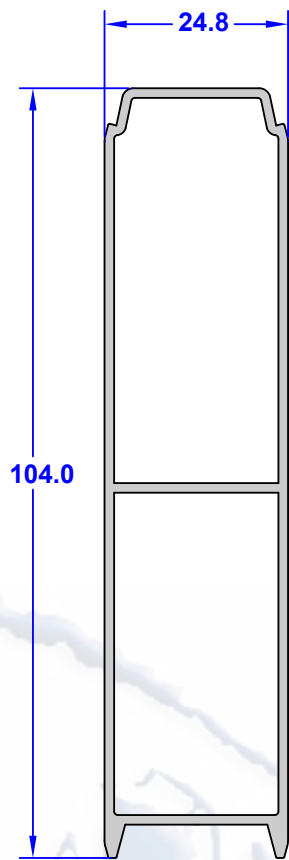

6174

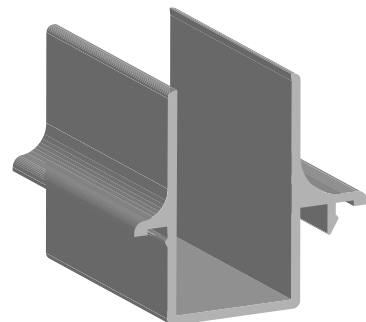
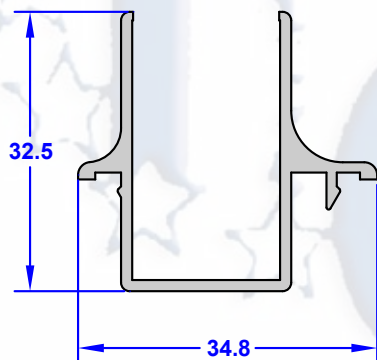

### TAPA TP 80x80

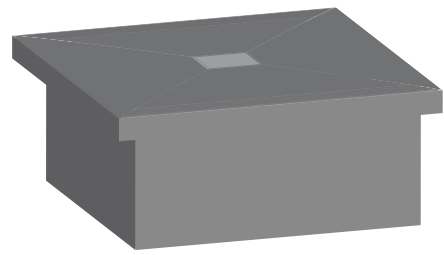
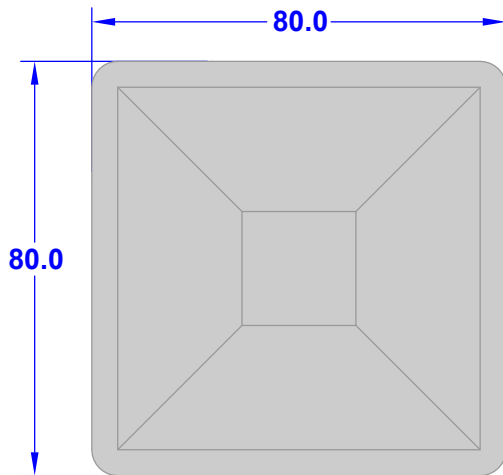

NYLON

ALUMINIO

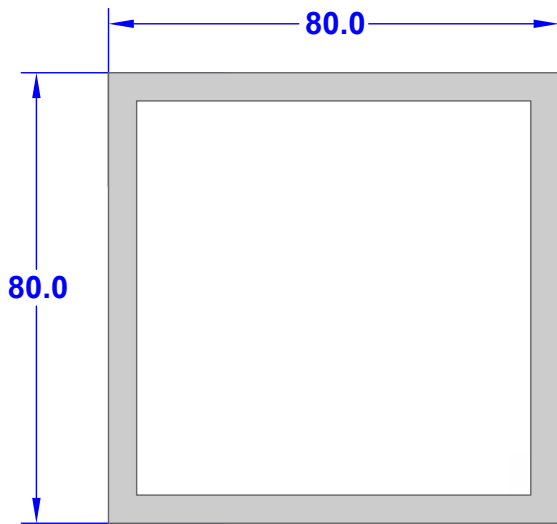

### TUBO CUADRADO 80x80

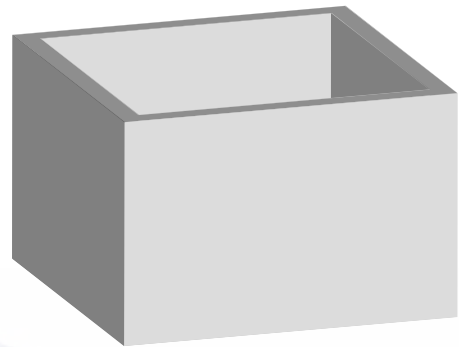

### PEANA CUADRADA 80x80

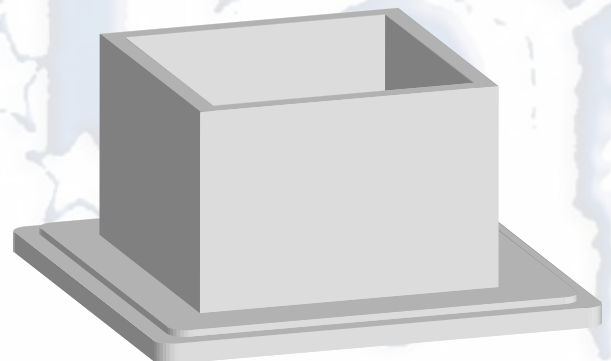
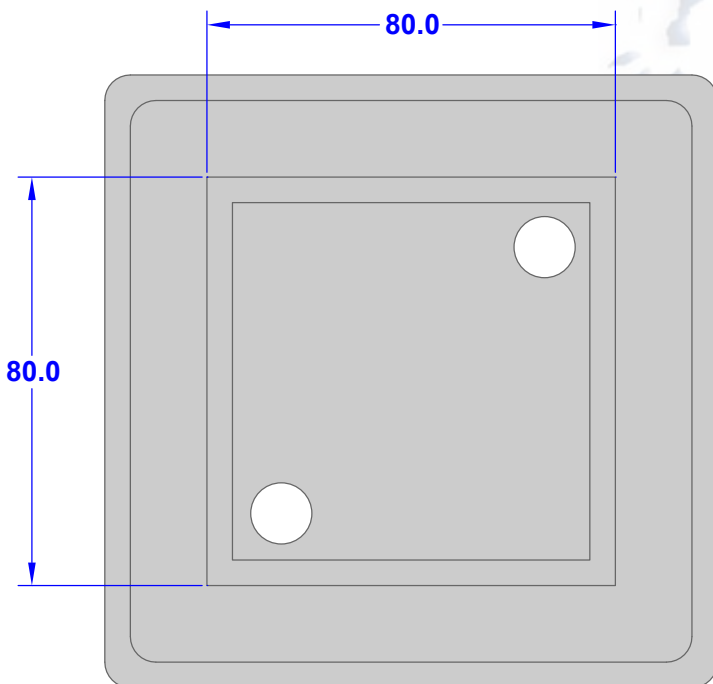

### TAPA TP 40x40

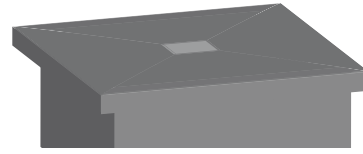
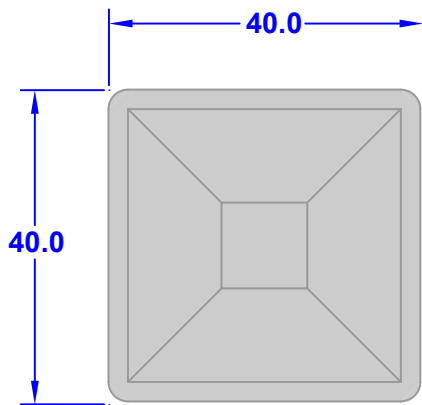

NYLON

ALUMINIO

### TUBO CUADRADO 40x40

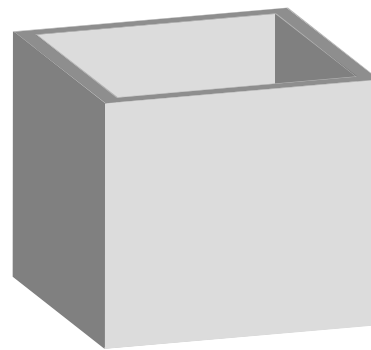
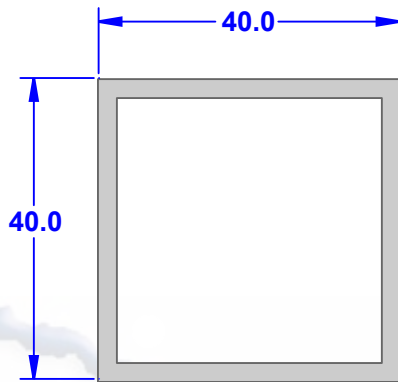

### PEANA CUADRADA 40x40

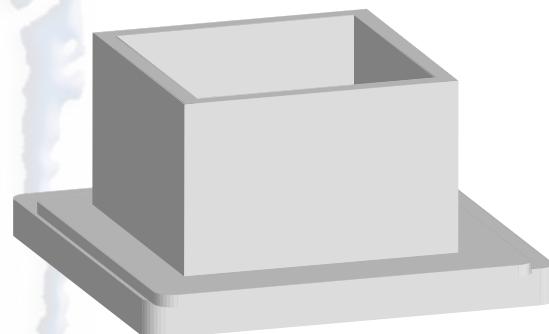
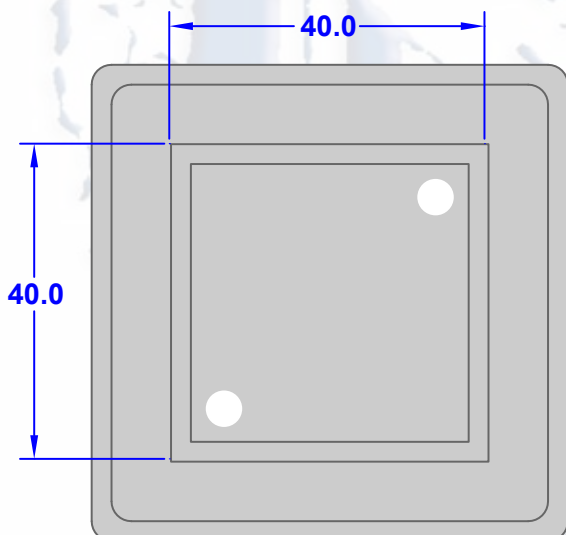

### TAPA TPR Ø60

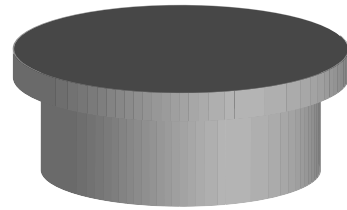
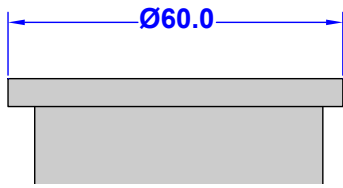

### TUBO REDONDO Ø60

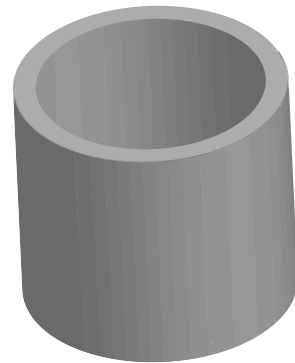
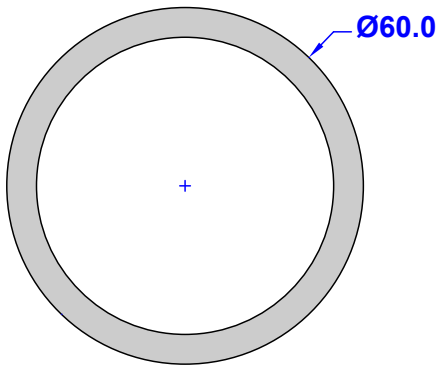

### PEANA REDONDA Ø60

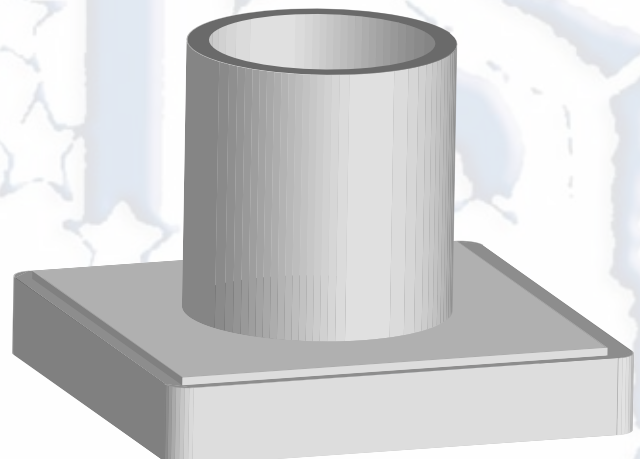
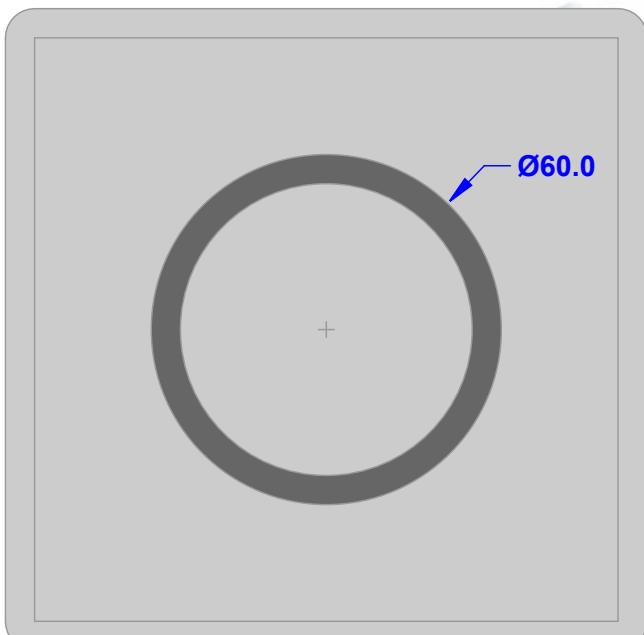



INDUSTRIAS CANYELLES BCN S.L.

## *PUERTAS CANCELAS*



FABRICANTES DE

**EXTRUAL**

SISTEMAS ■ ■ ■



## CANCELAS CORREDERAS

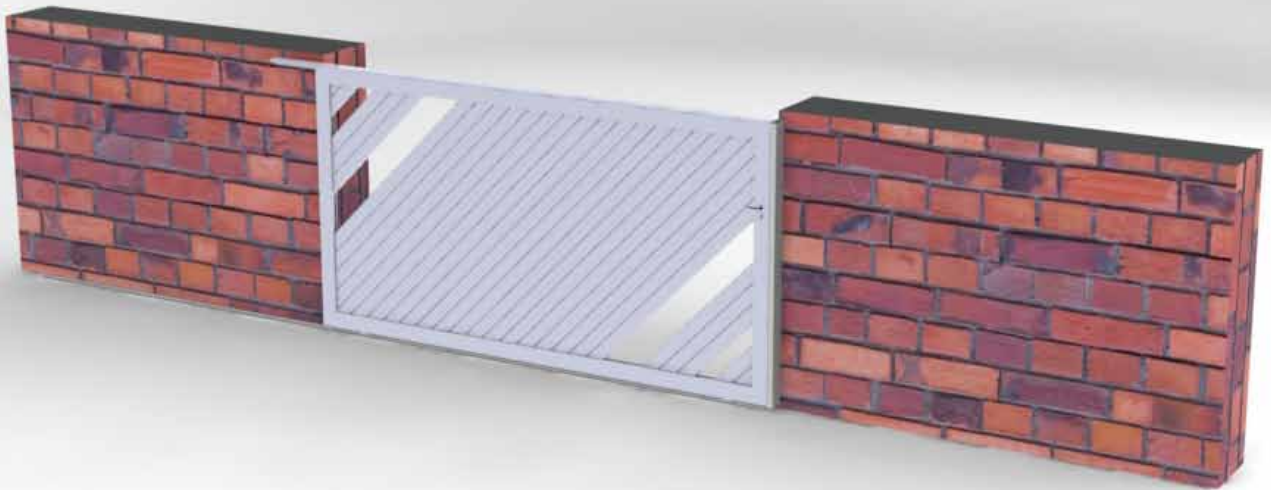

LAMA MACHEMBRADA DIAGONAL CON SEPARACION

*ALANA*

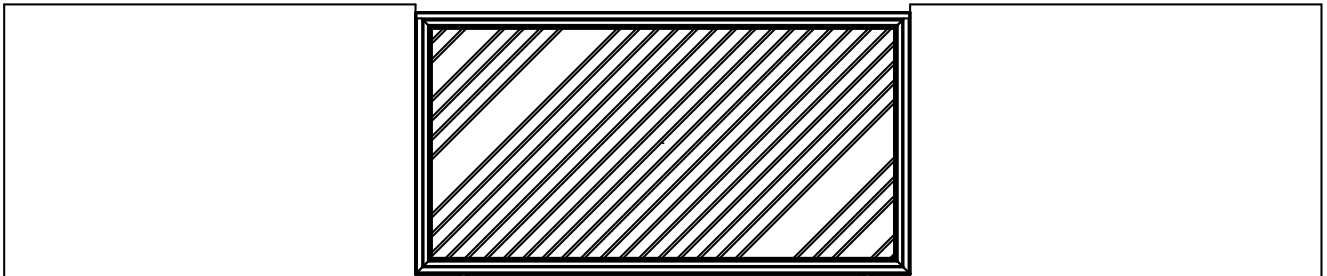

*DARLA*

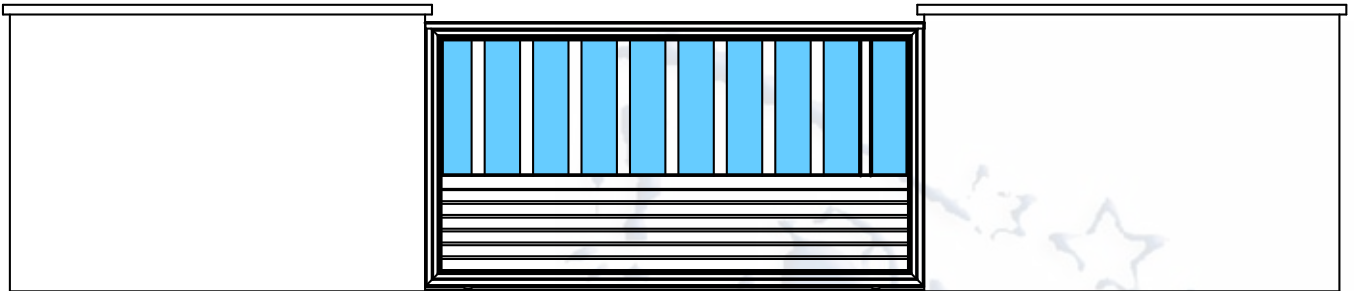

DIVISION CON VIDRIO

PARTE INFERIOR LAMA MACHEMBRADA



## CANCELAS CORREDERAS



DIVISION DIAGONAL

**AMIRA**

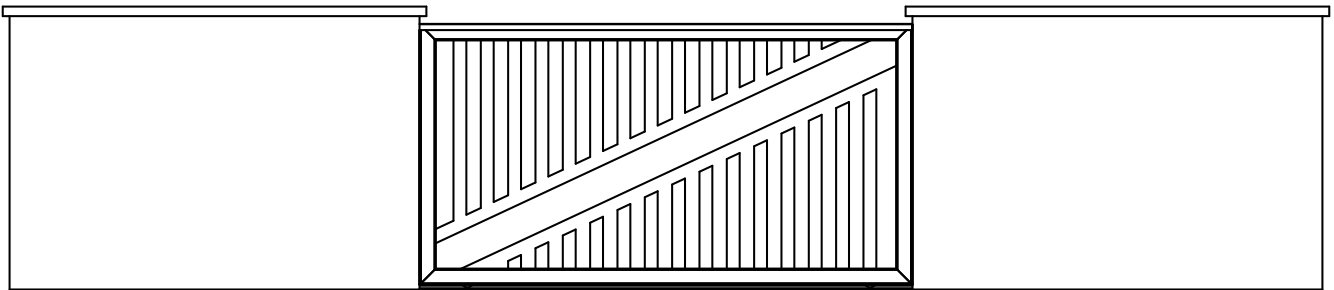

**ELBA**

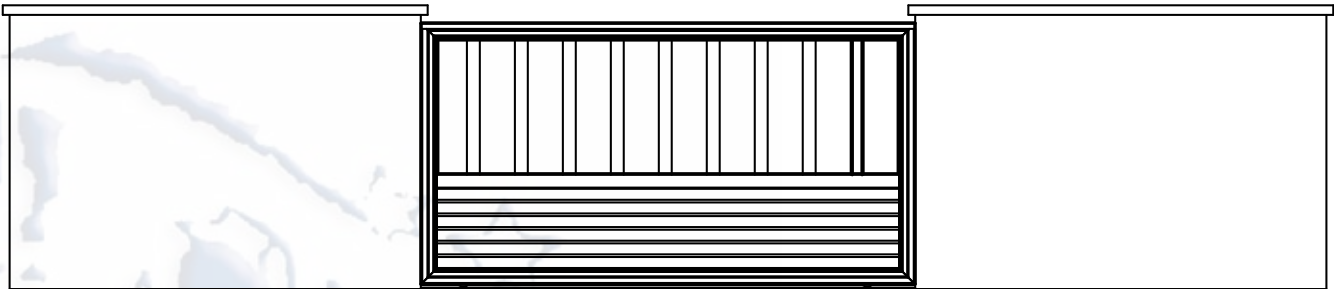

DIVISION

PARTE INFERIOR LAMA MACHEMBRADA



## CANCELAS CORREDERAS

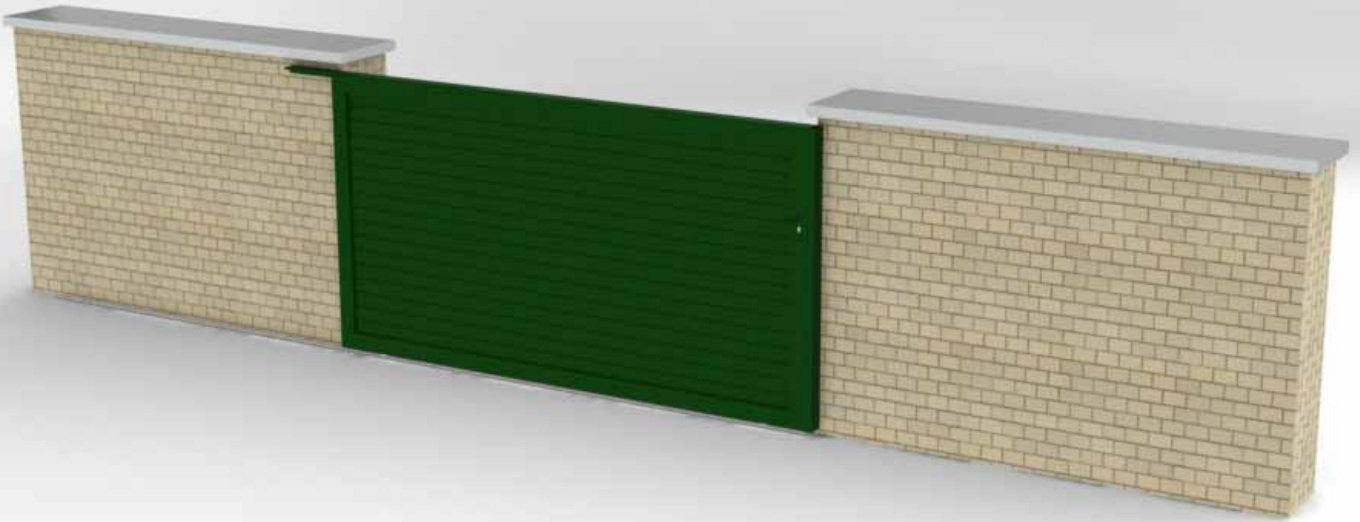

LAMA MACHEMBRADA HORIZONTAL

*DALIA*

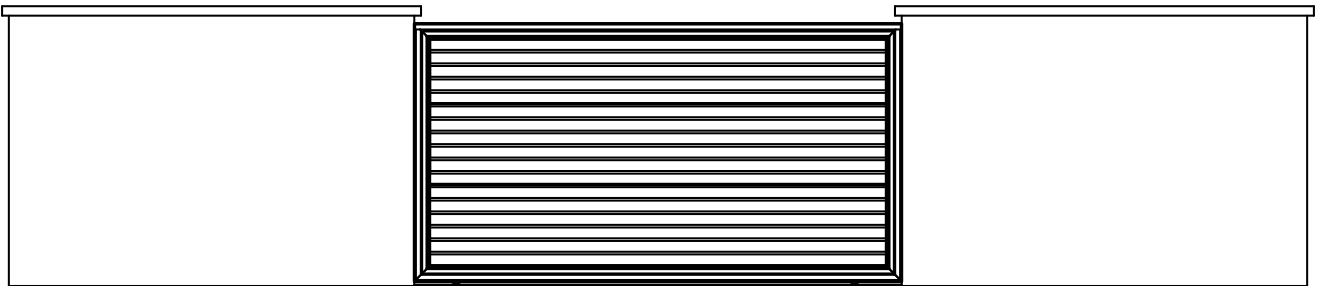

*NARA*

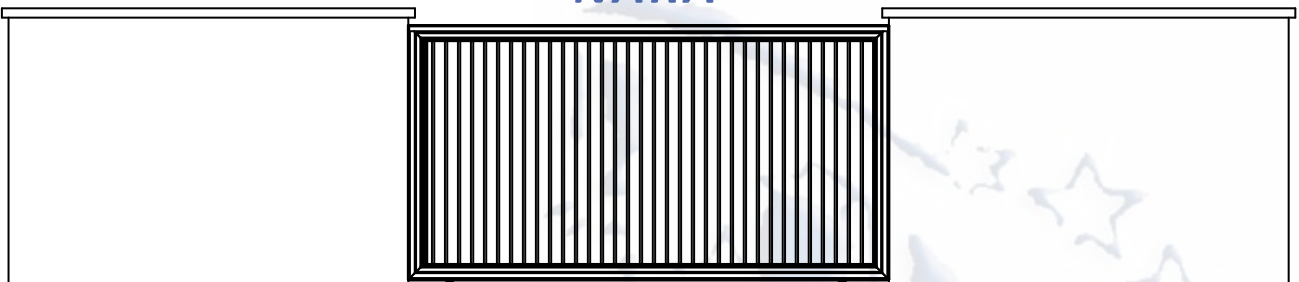

LAMA MACHEMBRADA VERTICAL

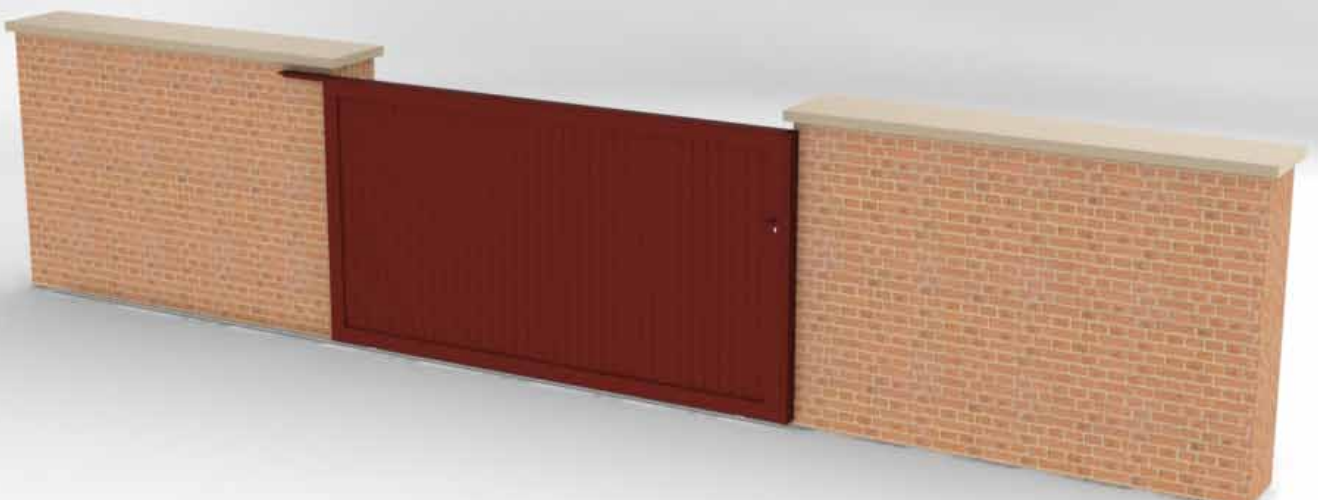

## CANCELAS CORREDERAS

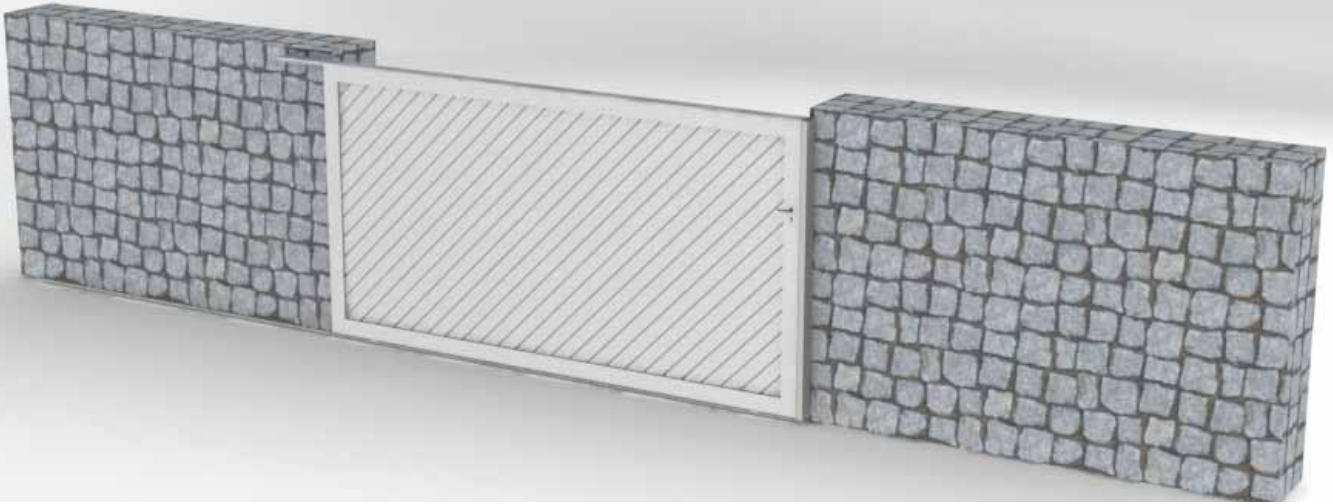

LAMA MACHEMBRADA DIAGONAL

*DANA*

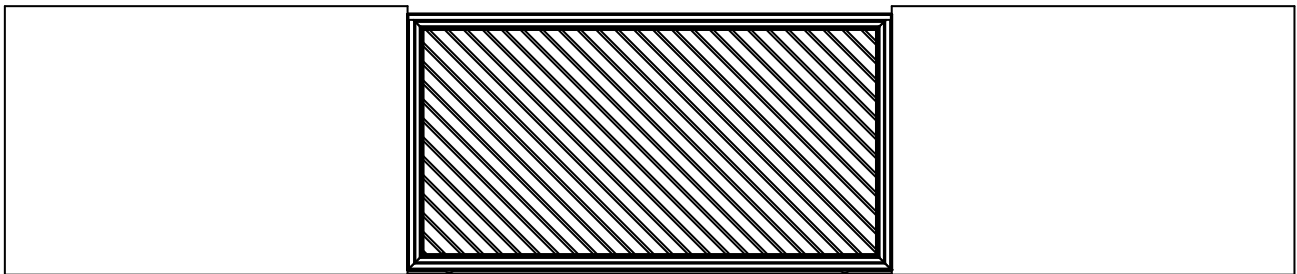

*IRINA*

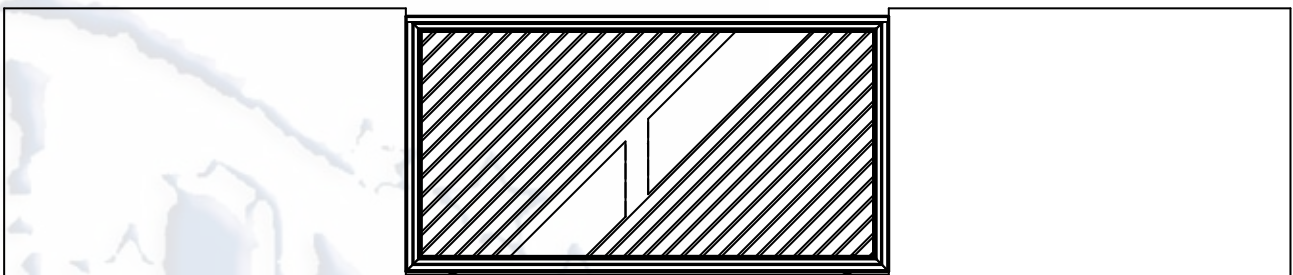

LAMA MACHEMBRADA DIANGONAL CON SEPARACION

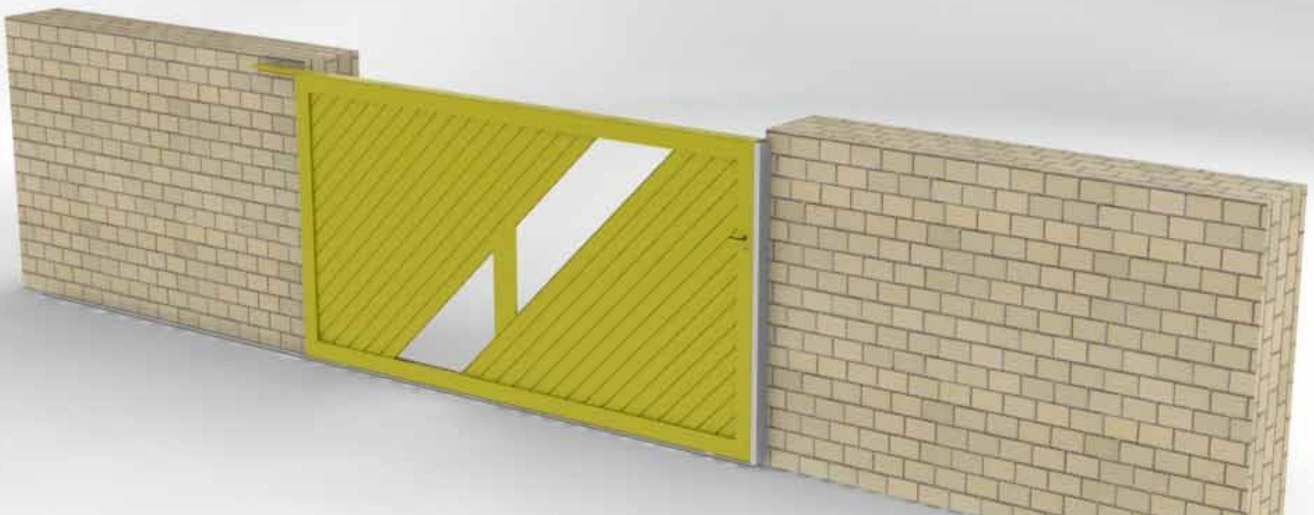

## CANCELAS CORREDERAS

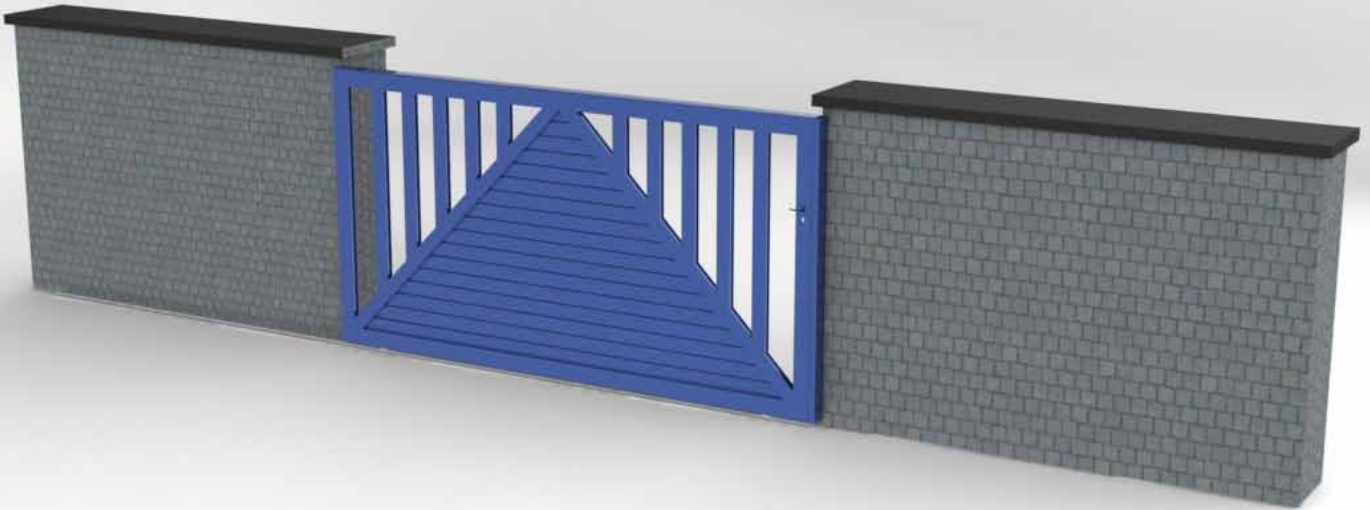

DIVISION PIRAMIDAL

*LENA*

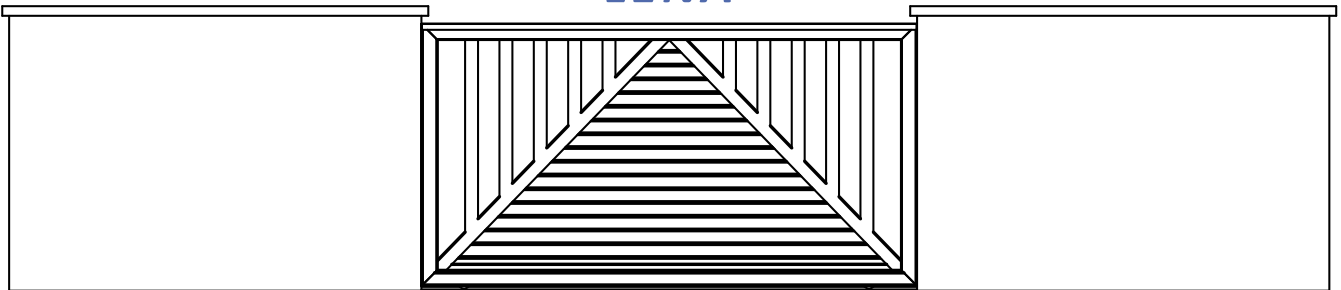

*KIRA*

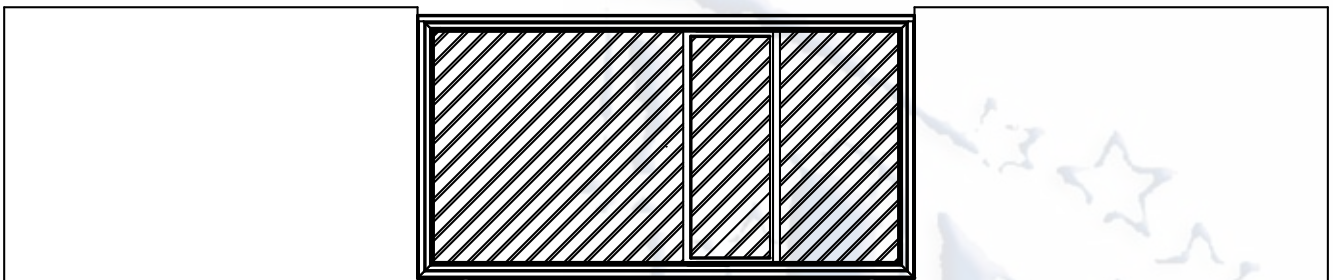

LAMA MACHEMBRADA DIAGONAL CON PUERTA PEATONAL



## CANCELAS CORREDERAS



BARROTE PARTE INFERIOR MACHEMBRADA

*ELINA*

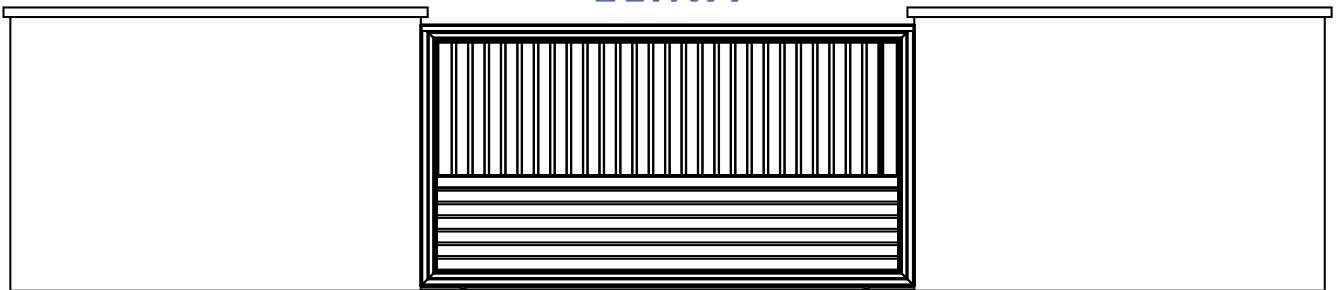

# SECCION VERTICAL

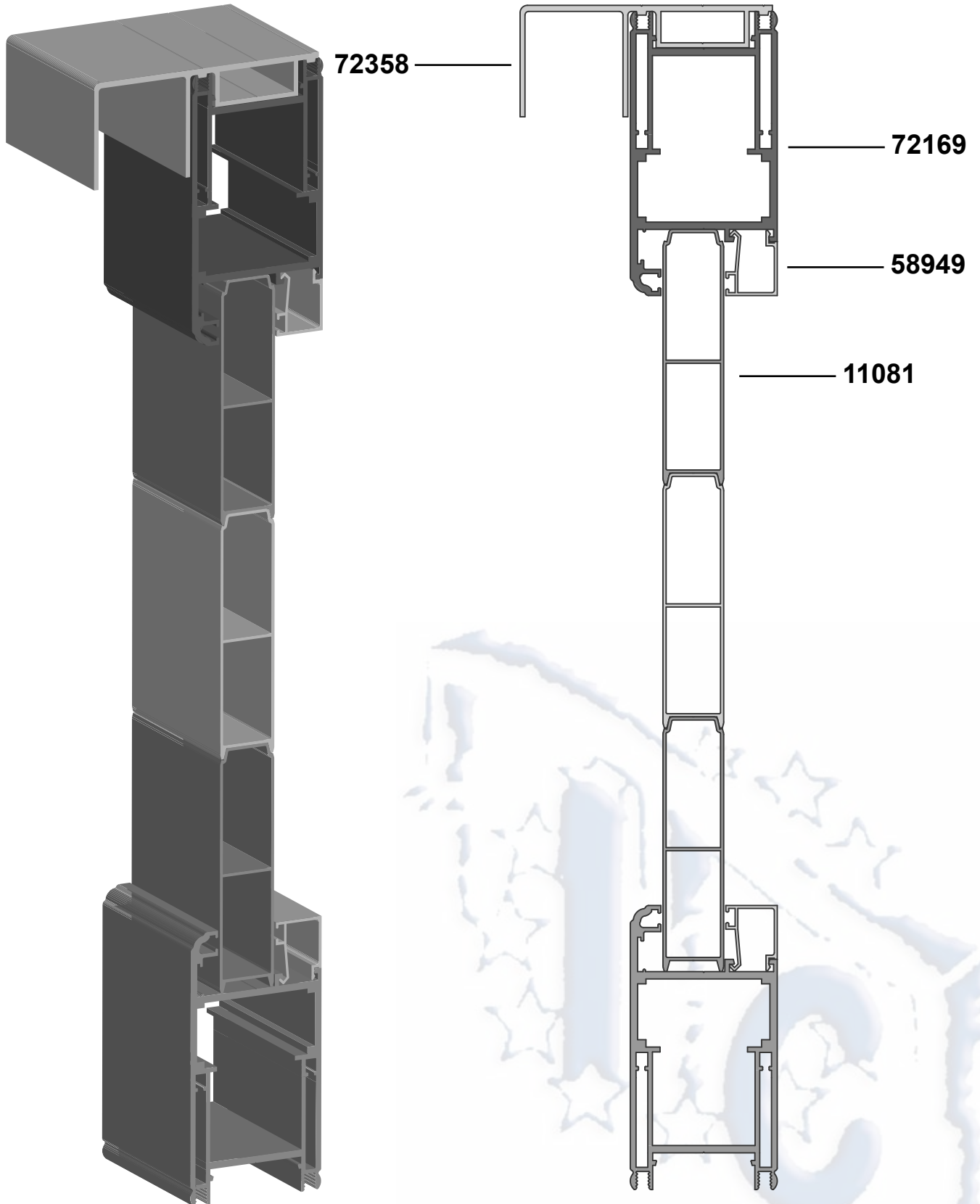

11081

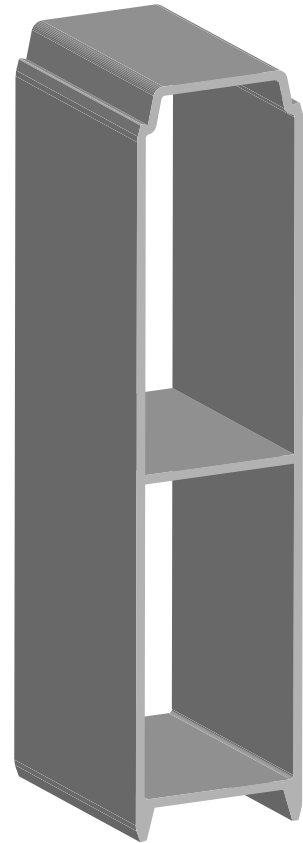
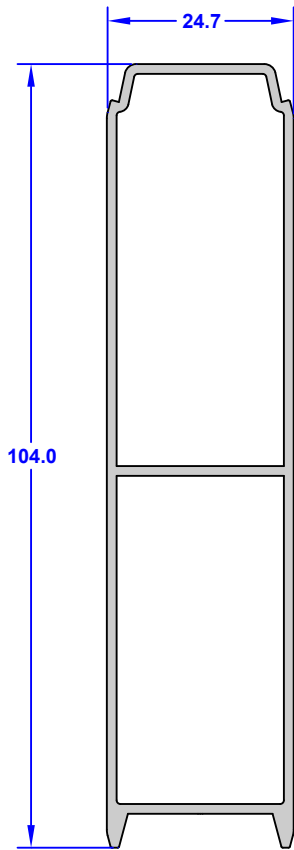

58949

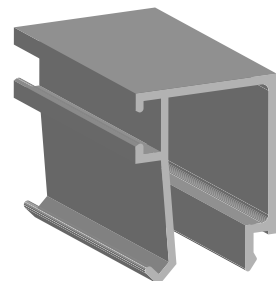
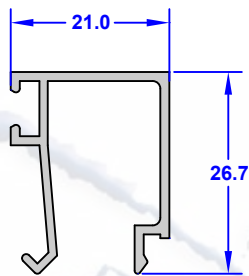

61142

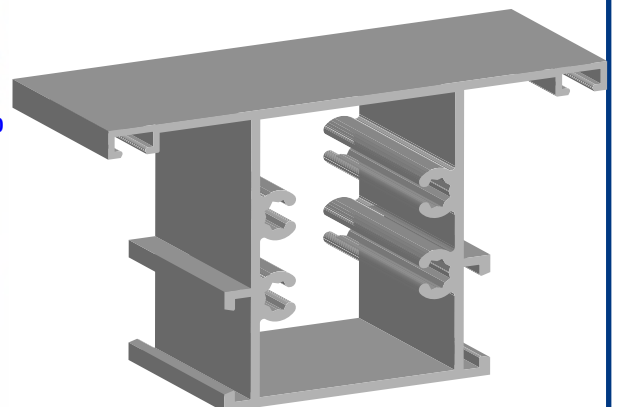
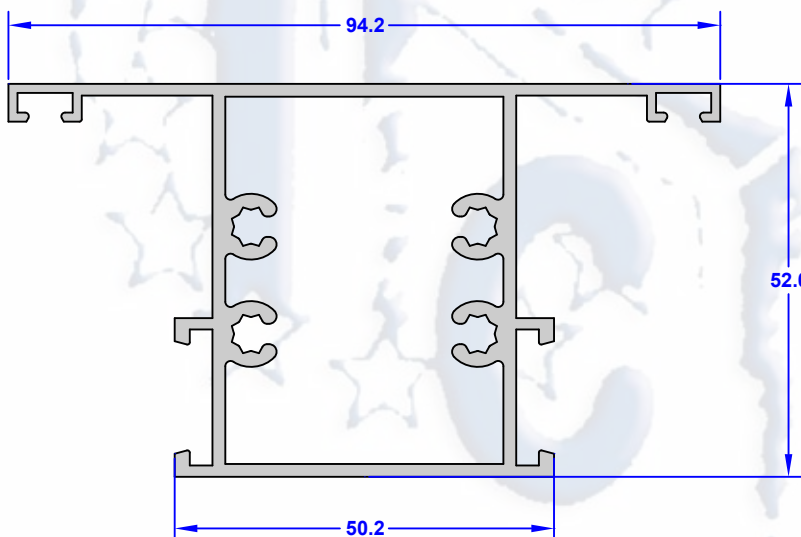



72169

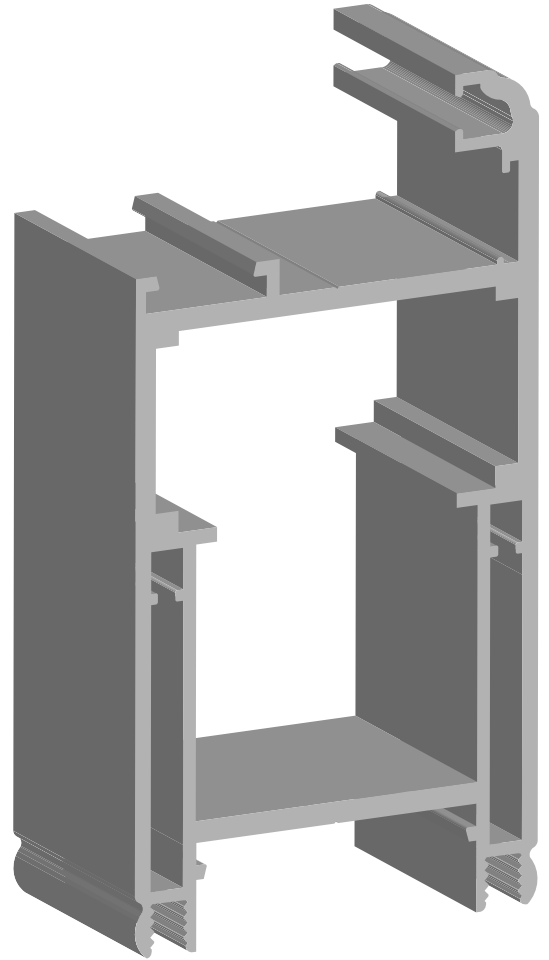
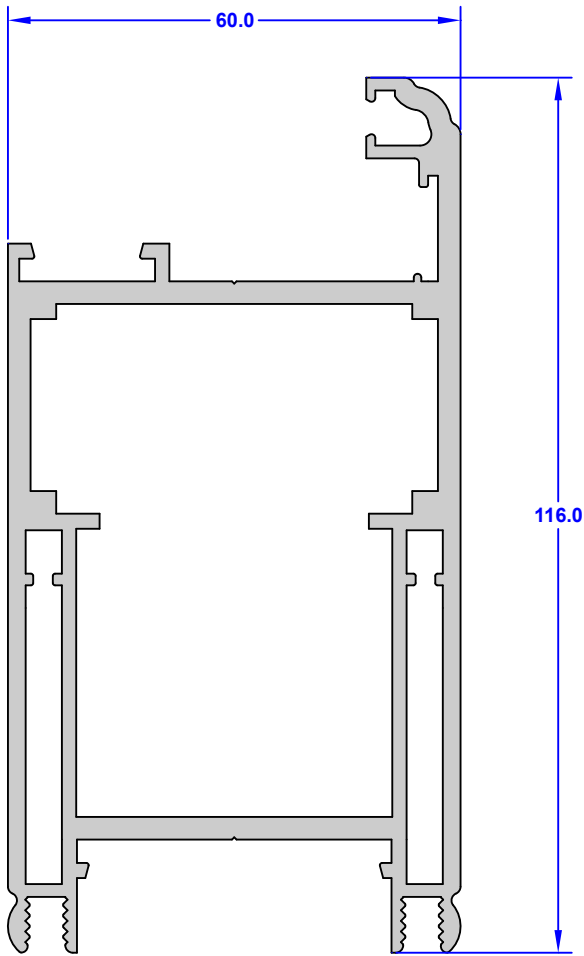

72171

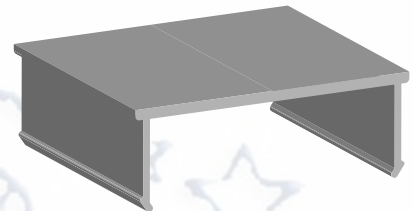
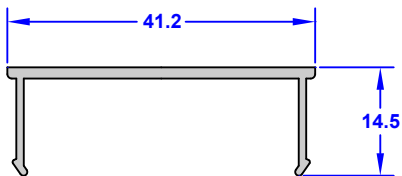

72358

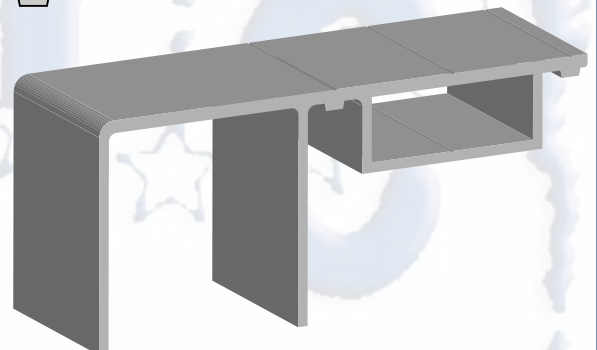
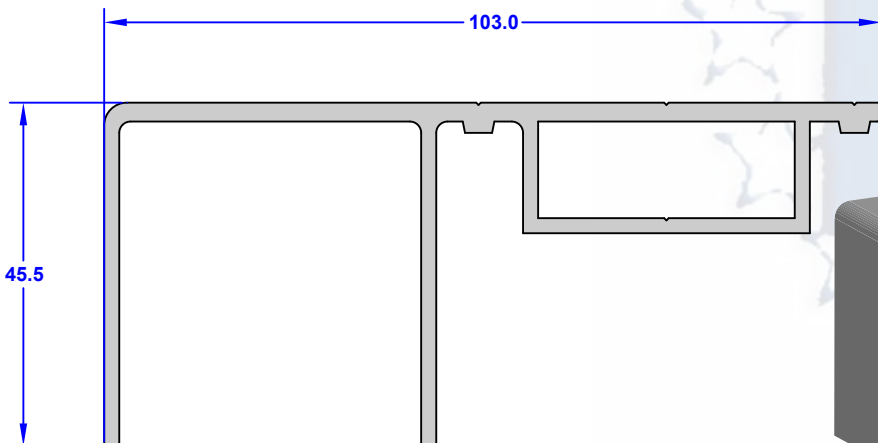

73123

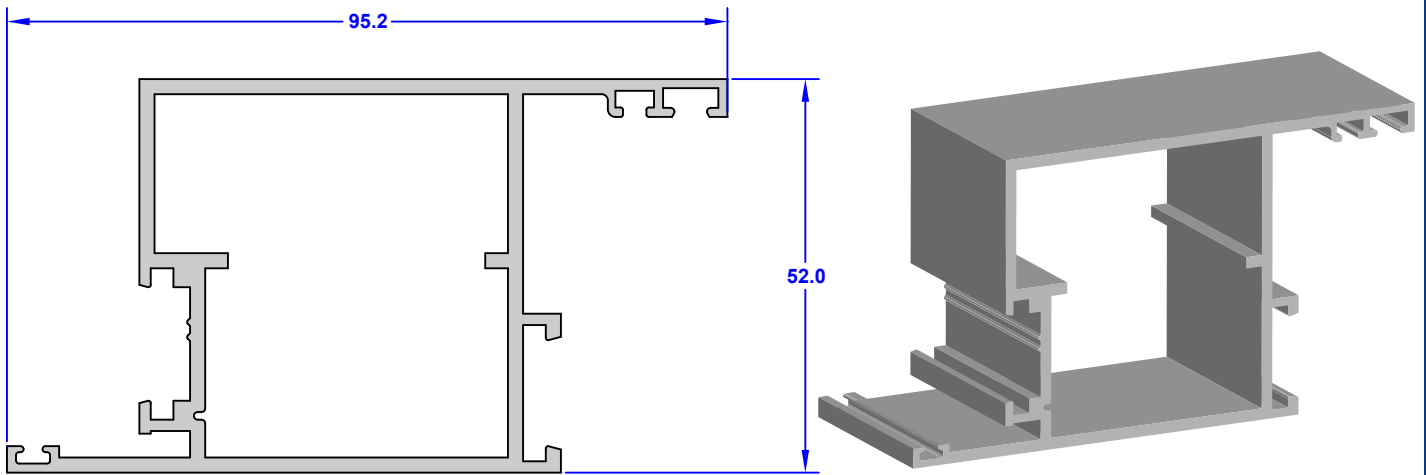

SECCION MONTAJE

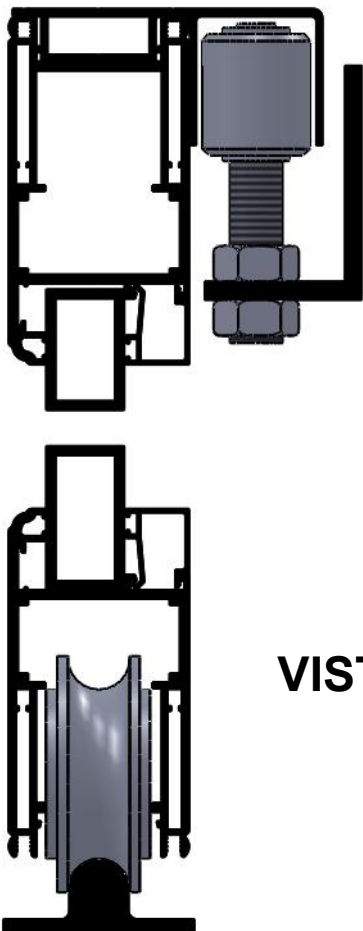
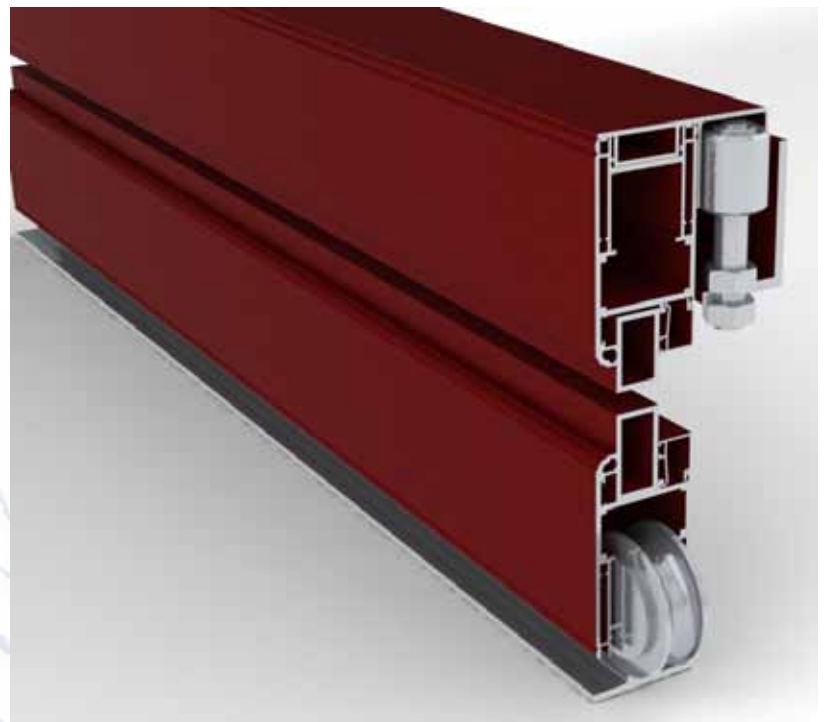

VISTA DETALLADA



VISITA NUESTRA PAGINA WEB Y PODRÁS CONSULTAR  
TODA NUESTRA GAMA DE PERFILES

<http://www.industriascanyelles.com>

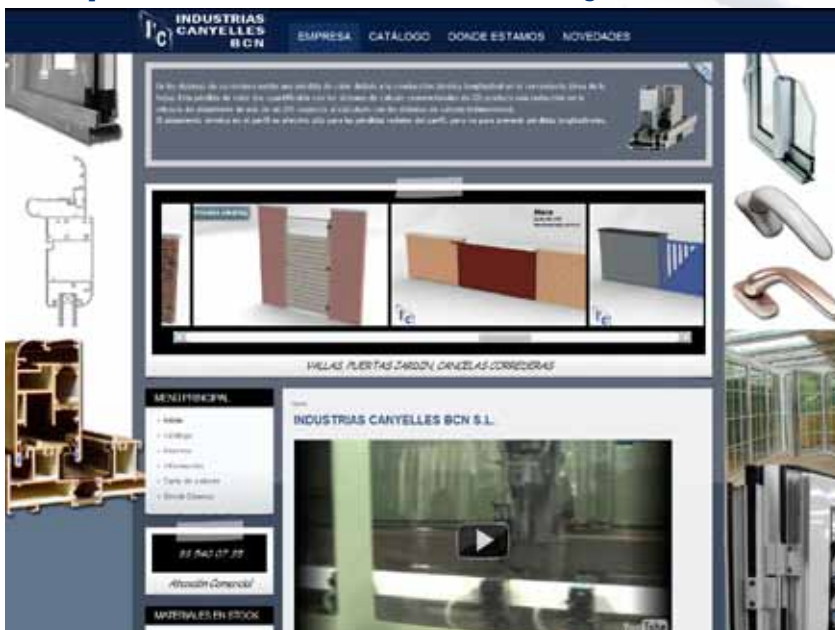

**VALLAS**  
**PUERTAS**  
**VENTANAS**  
**CORREDERAS**  
**BARANDILLAS**  
**PRACTICABLES**  
**MALLORQUINAS**  
**COARRUGABLES**  
**PUERTAS JARDÍN**  
**CANCELAS CORREDERAS**

Descubra en nuestra Web un amplio catálogo de series propias de carpintería que podrá utilizar en sus proyectos de obra o arquitectura.

Disponemos de una amplia gama de soluciones en perfilaría de aluminio de alta calidad para cubrir todas sus necesidades.



## Serie Mixta 67

### Corredera 60-70

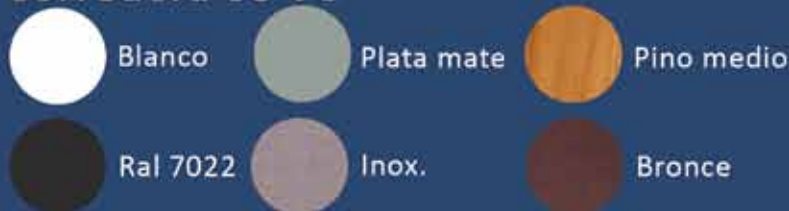

## Serie INNOVA 7

### Corredera 70



## E75 EVOLUTION

### Corredera 80 RPT

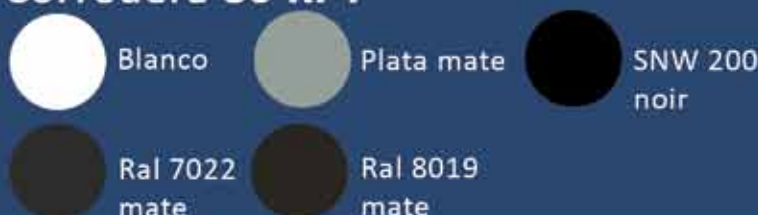

## Serie 80 RPT

### Corredera 100 RPT



## Practicables

### Exclusive 60x50



## Practicables

### Rotura 25/70

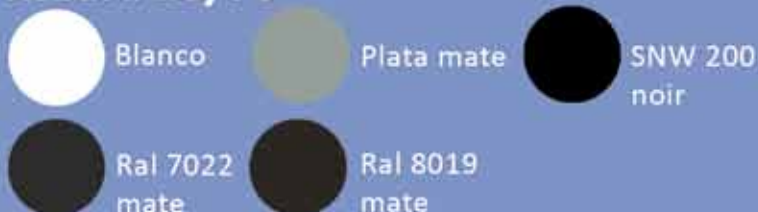

## Mallorquina

### Lama fija / Lama movil

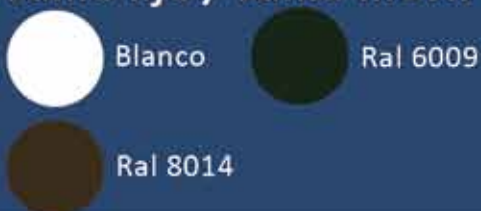

## Canal 16 Canal 16 RPT



# Nuestras Series...



**INNOVA 6  
CORREDERA 60**



**INNOVA 7  
CORREDERA 70**



**SERIE 80  
CORREDERA  
ELEVABLE**



**ENRASADA 45  
PRACTICABLE**



**CANAL 16  
PRACTICABLE**

**EXCLUSIVE 60x50  
PRACTICABLE**



## PUERTAS PRIVILEGE



además disponemos de:  
Mallorquinas, Puertas jardín,  
Vallas, Cancelas, Coarrugables,  
Pivotantes, Barandillas...

Visita nuestro catálogo en internet  
[www.industriascanyelles.com](http://www.industriascanyelles.com)

Atención comercial: 93 540 07 35  
Email: [info@industriascanyelles.com](mailto:info@industriascanyelles.com)

## ROTURA PUENTE TERMICO



**GOS-S**



**EVOLUTION  
75 RPT**



**80 RPT  
CORREDERA  
ELEVABLE**



**E 60 RPT 135  
CORREDERA  
ELEVABLE**



**135 RPT  
CORREDERA  
ELEVABLE**



**17 RPT**

**25/70  
PRACTICABLE**



**CANAL 16 RPT  
PRACTICABLE**



**MONO RAIL  
PRACTICABLE**



### ALUDECOR

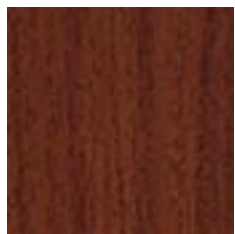

ACACIA A7

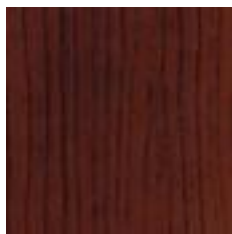

ALISO



CASTAÑO

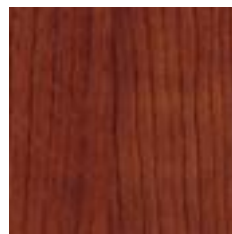

CEDRO

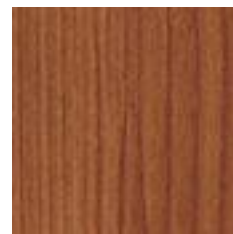

CEREZO DORADO



CEREZO G7



CEREZO CATEDRAL



DOUGLAS EUROPEO



DOUGLAS G8



EMBERO



HAYA



NOGAL B7



PINO ENVEJECIDO



PINO MOBILA



PINO-NUDO



ROBLE ASSI

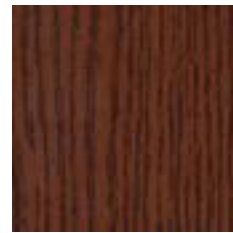

ROBLE E7



ROBLE GOLDEN



ROBLE K8

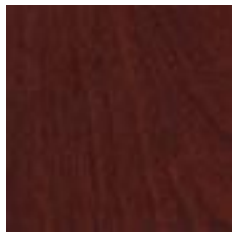

SAPELLY CAOBA



SAPELLY BURDEOS

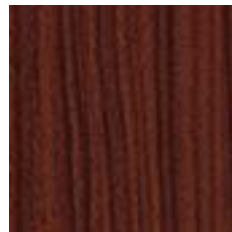

SAPELLY MARRON

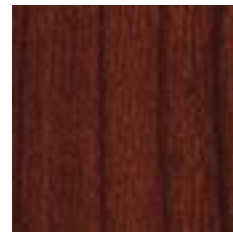

TEKA

### MADERA



ACACIA MEDIA



ACACIA OSCURA



CASTAÑO OSCURO



CEREZO

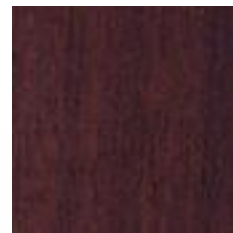

NOGAL OSCURO



NOGAL V7

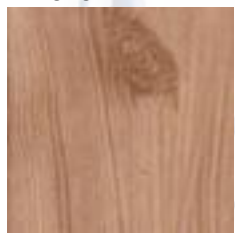

PINO CLARO

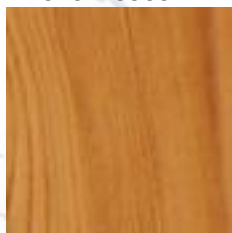

PINO NUDO

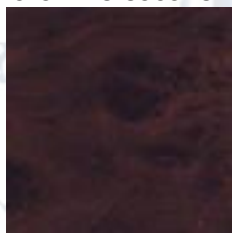

RAIZ OSCURO

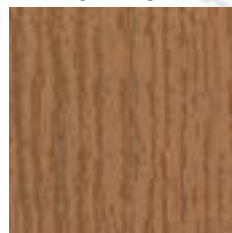

ROBLE CLARO

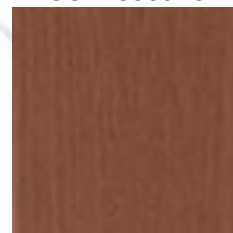

ROBLE MEDIO



SAPELLY OSCURO

### REPULIDOS



ANODIZADO



BRONCE CLARO



INOX IXRP

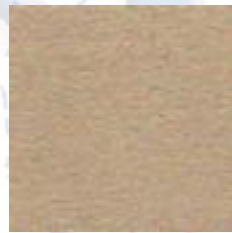

ORO RP



ORO OD



PLATA SATINADA



RAL



1001

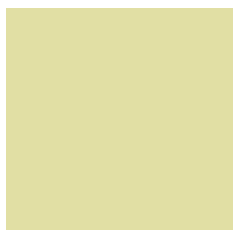

1013

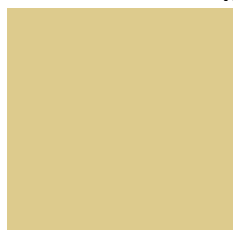

1015

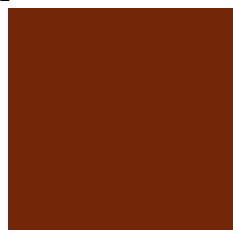

3000

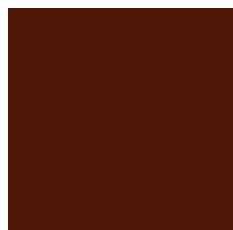

3003

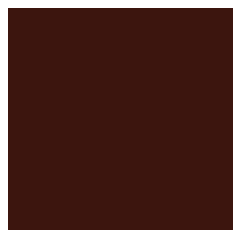

3005

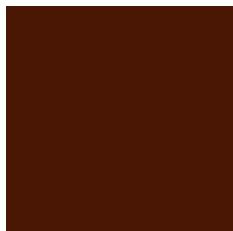

3011



5010



5013

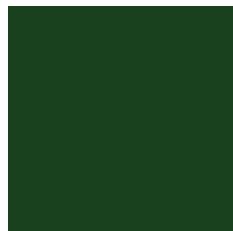

6002



6005



6009

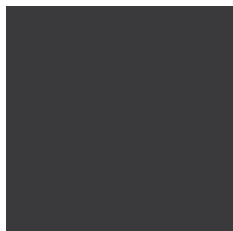

7012

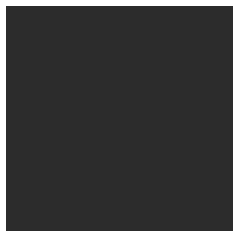

7022



7031



7035

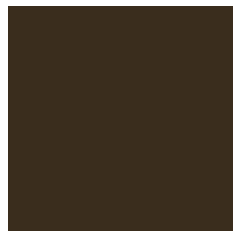

8014

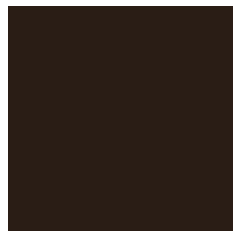

8017



8019

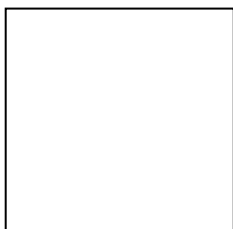

9010

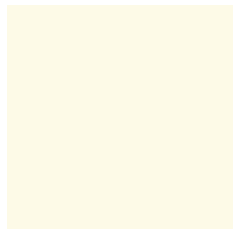

9010F

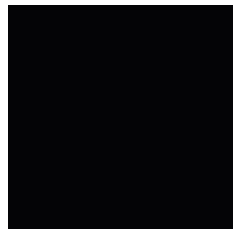

9011B

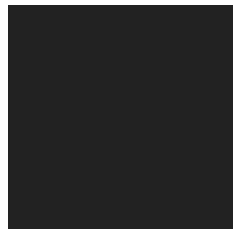

9011 MATE



34000

SABLE FUTURA

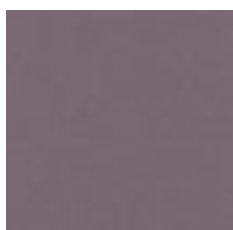

ACIER

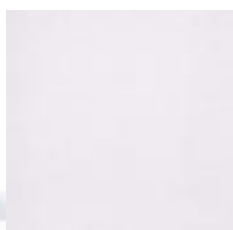

ANNA PURNA



ATLANTE

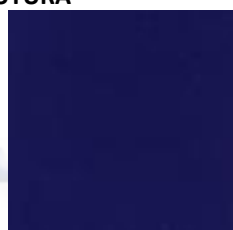

BALTIC

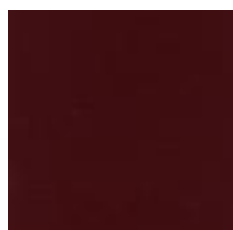

BAMENGA

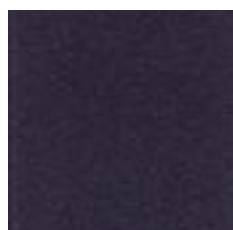

BLEU 600 SABLE



BLEU 500 SABLE



BLEU 700 SABLE



BLEU 2600 SABLE



BLEU SABLE 2700

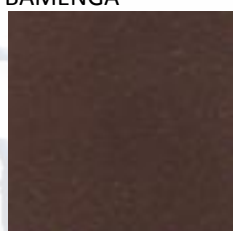

BRONZE



BRUN 650 SABLE



CANON

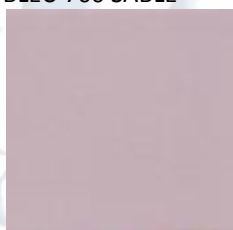

CHARDAIA



CORRICELLA

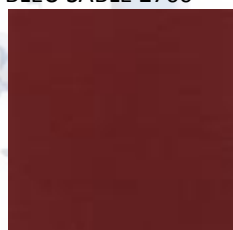

CUIVRE

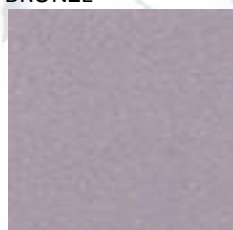

GALET

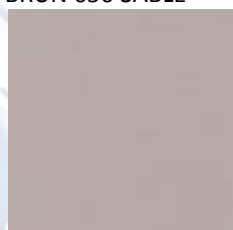

GOBI



GRIS 900 SABLE



GRIS 150 SABLE

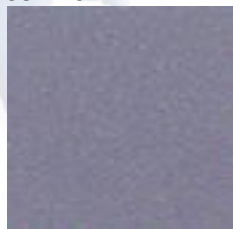

GRIS SABLE 250



GRIS 400 SABLE

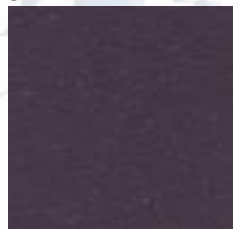

GRIS 2009 SABLE



GRIS 2500 SABLE



## **INDUSTRIAS CANYELLES BCN S.L.**

**Tel. 93 540 07 35 - Fax. 93 540 05 87**

**Pol. Ind Buvisa - c/ Industria, 7**

**08329 - Teià - Barcelona**

**info@industriascanyelles.com**

**Mas Información:**

**[www.industriascanyelles.com](http://www.industriascanyelles.com)**